



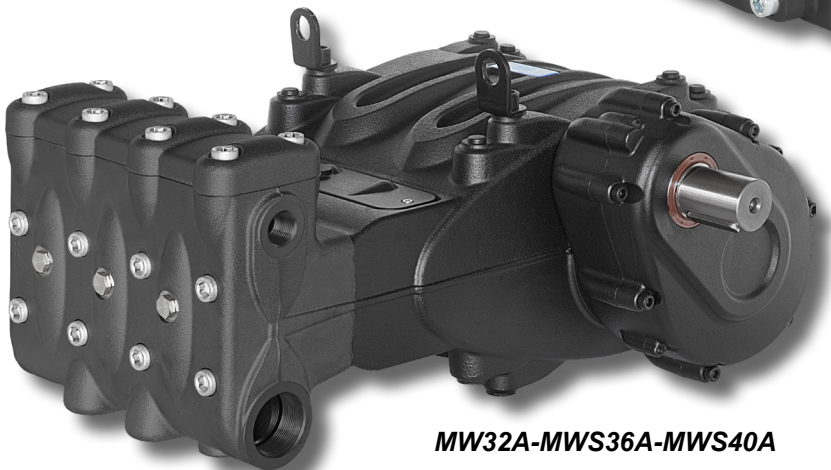
MW

Serial # 19177008 and later

Repair Manual



MWS45A-MWS50A-MWS55A



MW32A-MWS36A-MWS40A

**Note: This manual covers
MW Pumps with serial
number 19177008 and later**



General Pump
is a member of
the Interpump Group



Ref 300791 Rev. H
10-23



INDEX

1. INTRODUCTION Page 3

2. REPAIR INSTRUCTIONS Page 3

 2.1 Repairing Mechanical Parts Page 3

 2.1.1 Disassembly of Mechanical Parts Page 4

 2.1.2 Assembly of Mechanical Parts Page 15

 2.1.3 Increase and Reduction Classes Page 27

 2.2 Repairing Hydraulic Parts Page 27

 2.2.1 Dismantling the MW32A, MWS36A, MWS40A Head-Valve Units ... Page 27

 2.2.2 Assembling the MW32A, MWS36A, MWS40A -Valve Units Page 31

 2.2.3 Dismantling the MWS45A, MWS506A, MWS55A Head-Valve Units. Page 37

 2.2.4 Assembling the MWS45A, MWS506A, MWS55A Head-Valve Units. Page 40

 2.2.5 Dismantling the Plunger Unit-Supports-Seals Page 45

 2.2.6 Assembling the Plunger Unit-Supports-Seals Page 48

3. SCREW CALIBRATION Page 52

4. REPAIR TOOLS Page 53

5. SPECIAL VERSIONS Page 54

 5.1 MWR - MWNR Pump Page 54

 5.1.1 Disassembly of the support seal unit Page 54

 5.1.2 Assembly of the support seal unit Page 55

6. MAINTENANCE LOG Page 57

1. INTRODUCTION

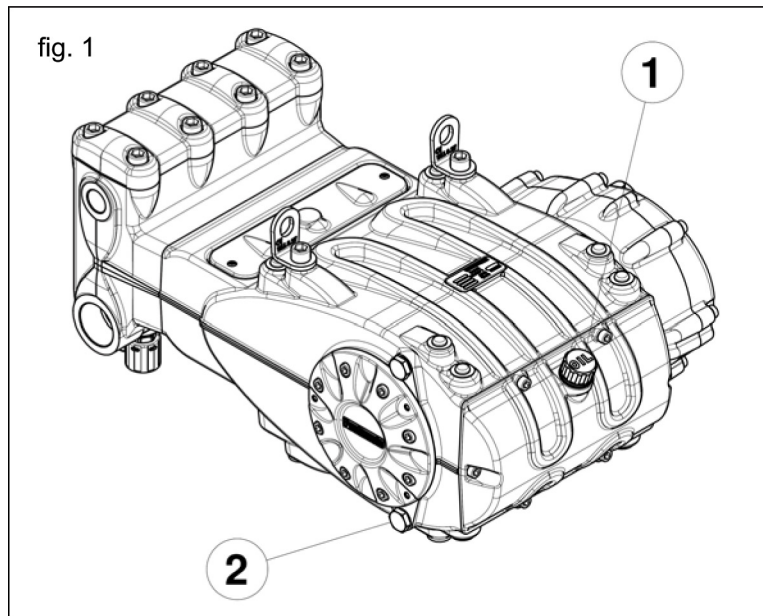
This manual describes the instructions for Repairing MW Series pumps, and must be carefully read and understood before performing any repair intervention on the pump. Proper pump operation and longevity depend on the correct use and maintenance. General Pump declines any responsibility for damage caused by the misuse or the non-observance of the instructions described in this manual.

2. REPAIR INSTRUCTIONS



2.1 Repairing Mechanical Parts

Mechanical parts repair must be performed after removal of oil from the casing. To drain the oil, remove the oil dipstick, (1, fig. 1) and then the draining plug (2, fig. 1).

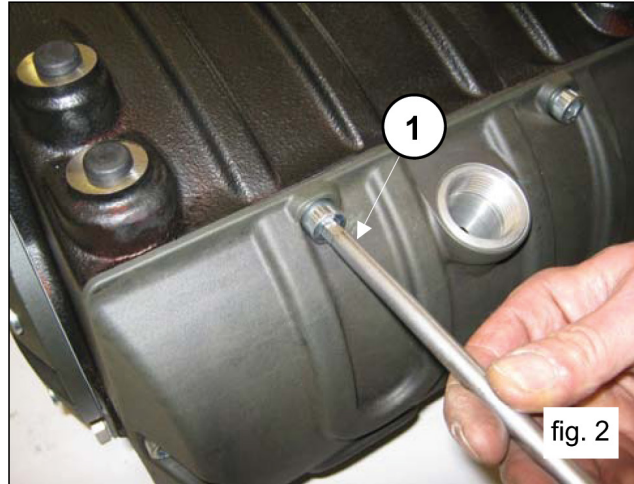


The oil must be placed in a suitable container and disposed of in special centers. It absolutely must not be discarded into the environment.

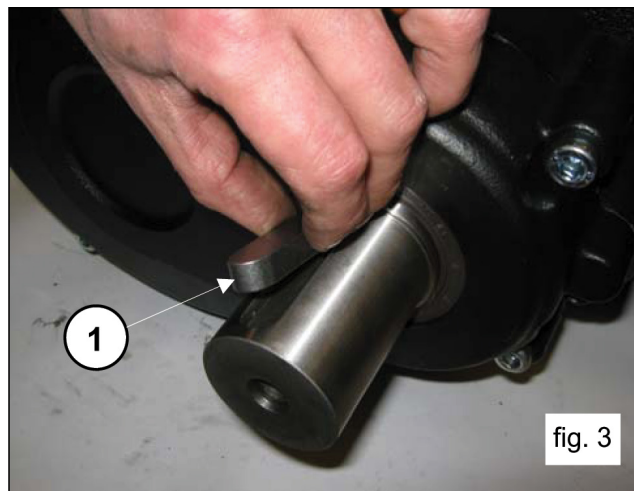
2.1.1 Disassembly of Mechanical Parts

The correct sequence is the following:

Completely drain the oil from the pump, then disassemble the casing cover (and relative o-ring), unscrewing the 6 M10 screws (1, fig. 2).



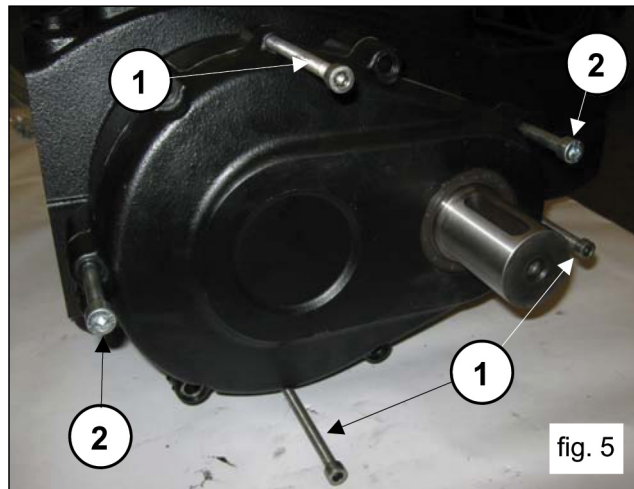
Remove the tab from the PTO shaft (2, fig. 3).



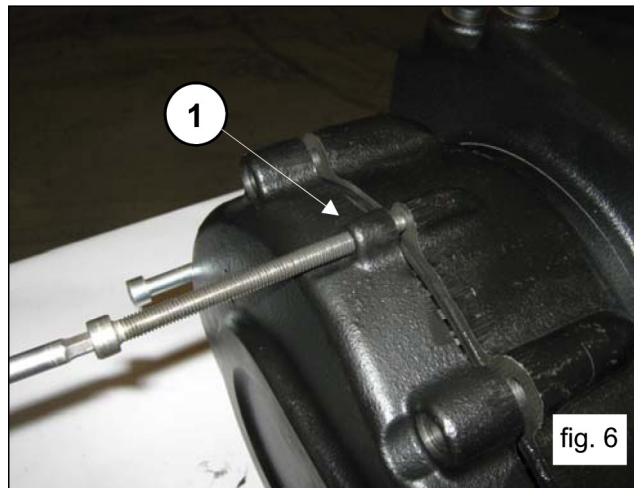
Unscrew the reduction gear cover fixing screws (1, fig. 4).



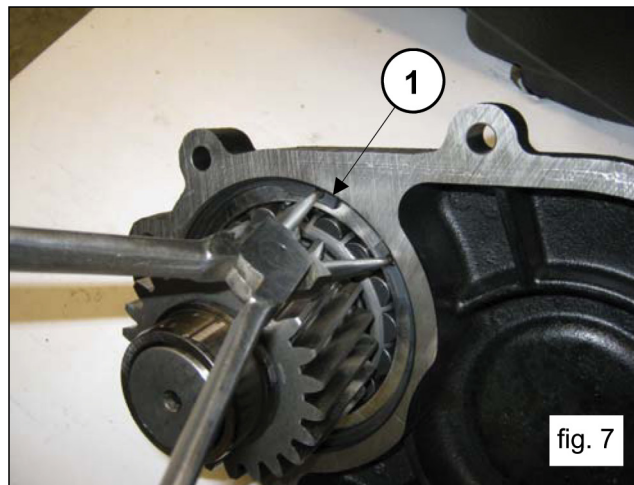
Position the 3 grub screws or M8 threaded screws (1, fig. 5) with the function of extractors in the holes and two sufficiently long M10 screws with the function of supporting the cover (2, fig. 5).



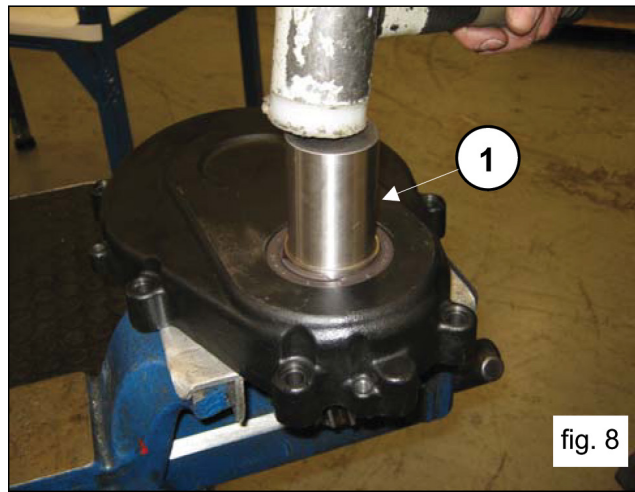
Slowly screw in the 3 M8 screws (1, fig. 6) with the function of extractors to fully remove the cover unit and pinion.



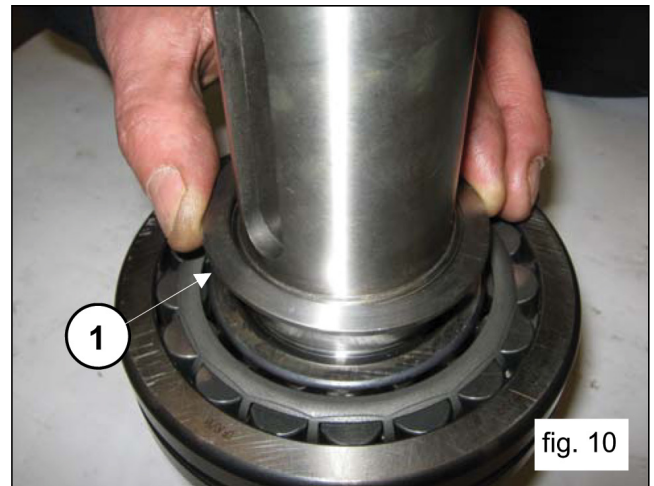
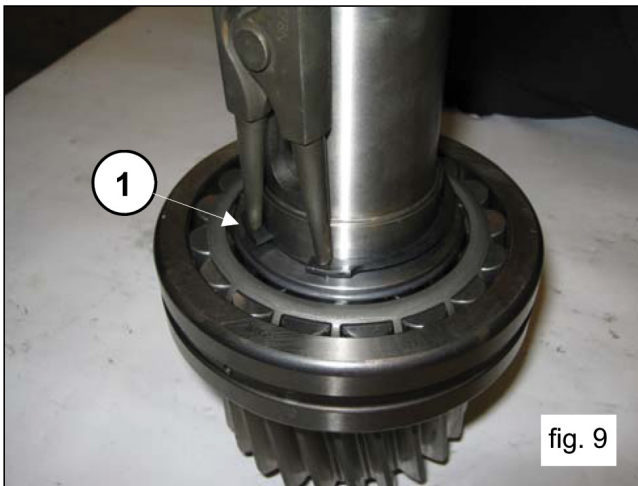
Complete disassembly of the reduction gear cover from the pinion is possible following these steps:
Remove the retaining ring Ø120 (1, fig. 7)



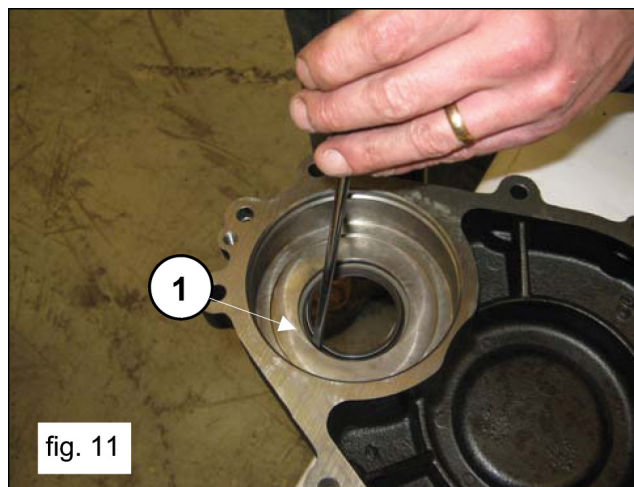
Separate the pinion from the cover, working with an extractor hammer on the pinion itself (1, fig. 8).



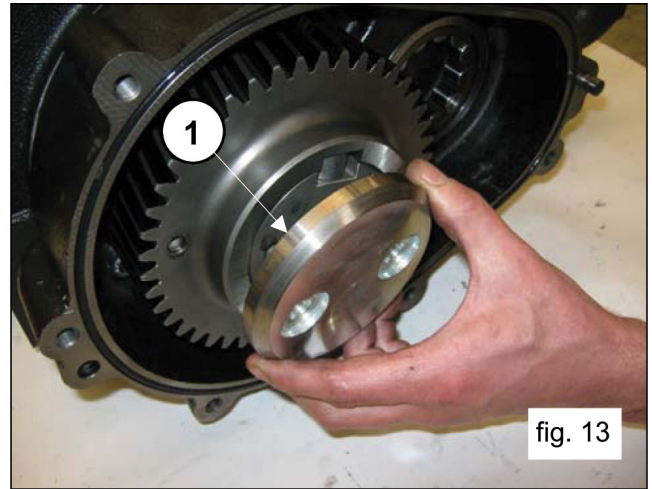
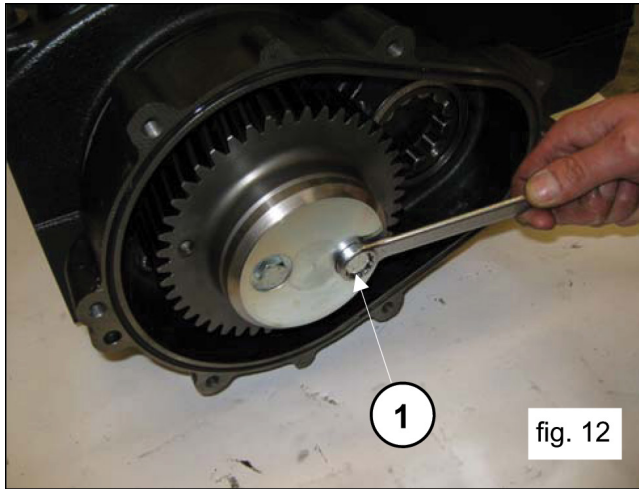
Remove the retaining ring Ø55 (1, fig. 9) and the bearing support ring (1, fig. 10) from the pinion.



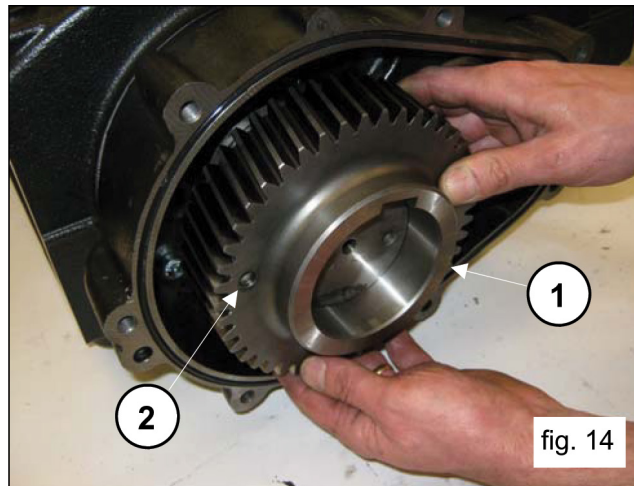
Extract the seal ring from the reduction gear cover, working from the inner side of the cover (1, fig. 11).



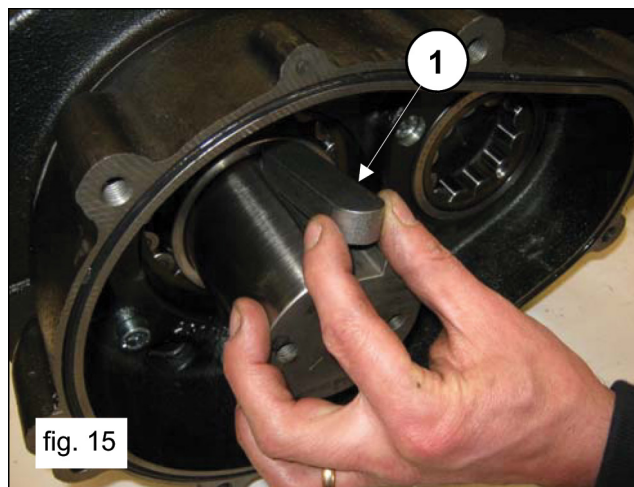
Unscrew the screws holding in the ring gear (1, fig. 12) and remove it (1, fig. 13).



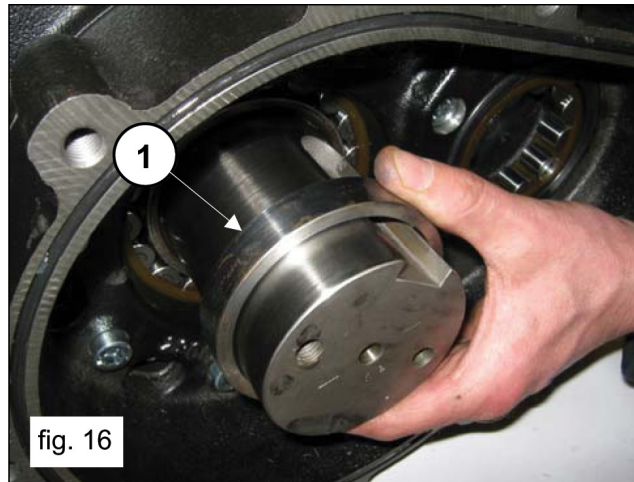
Remove the ring gear (1, fig. 14). Where necessary, it is possible to utilize an extractor hammer to be applied on the 2 M8 holes (2, fig. 14).



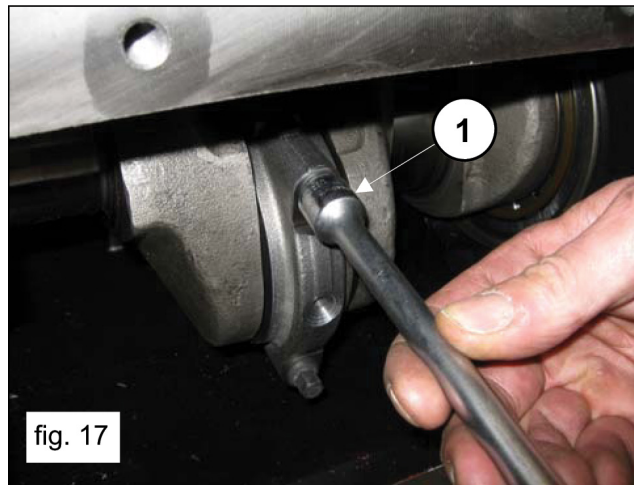
Remove the key from the shaft (1, fig. 15).



Remove the ring gear support ring (1, fig. 16).



Unscrew the connecting rod screws (1, fig. 17).

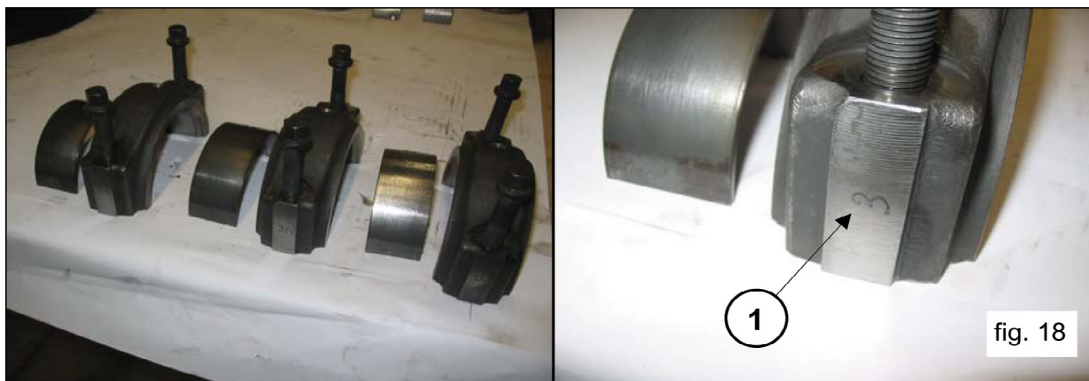


Remove the connecting rod caps with the lower semi-bearings, taking special care of the disassembly sequence during disassembly.

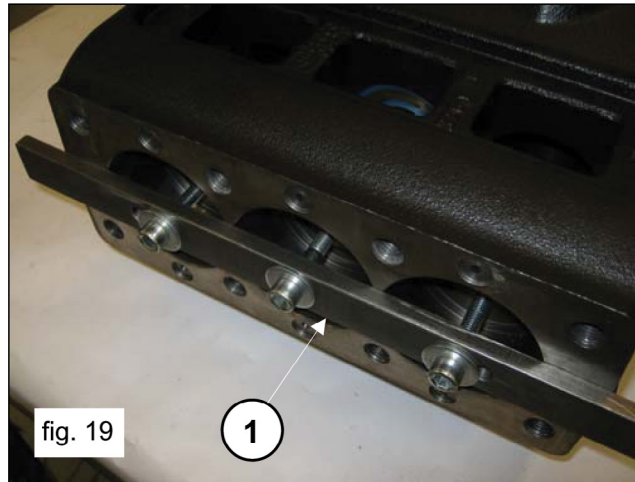


The con-rod caps and their relative half supports must be reassembled in exactly the same order and coupling with which they were disassembled.

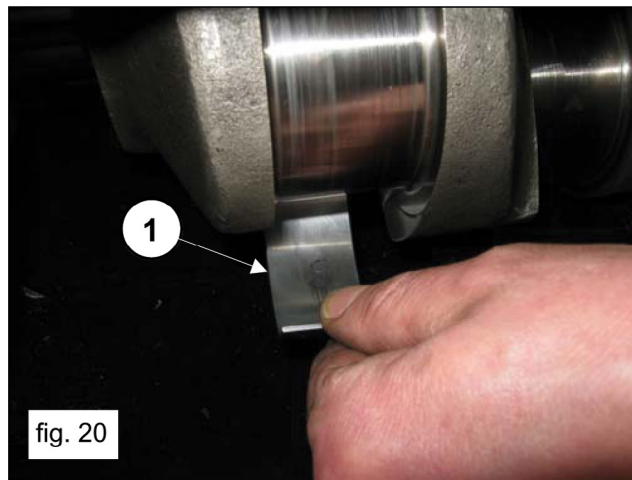
To avoid possible errors, caps and half-supports have been numbered on one side (1, fig. 18).



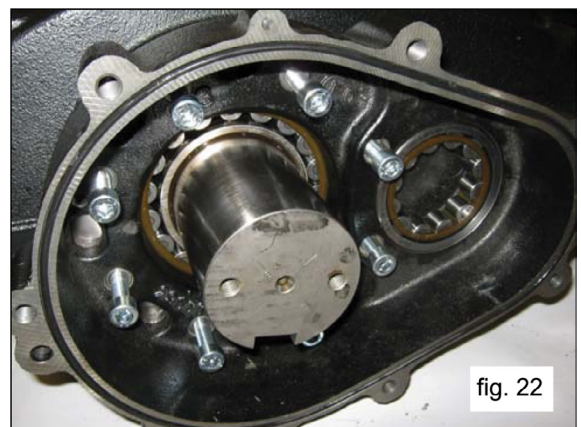
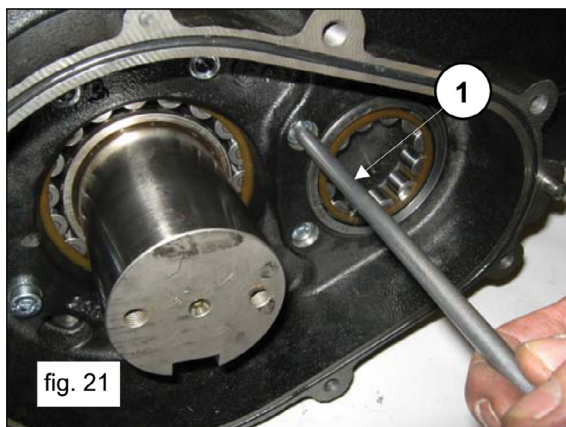
Advance the half supports completely in the direction of the pump head to allow the crankshaft to come out. To facilitate this operation, use special tool (p/n F27566200) (1, fig. 19).



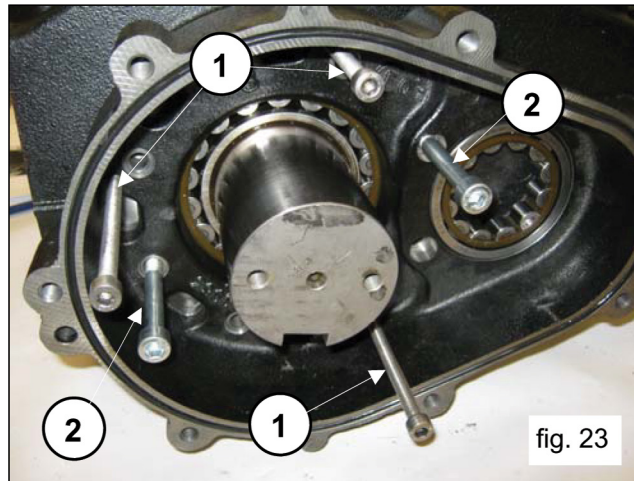
Remove the three upper half-bearings of the half supports (1, fig. 20).



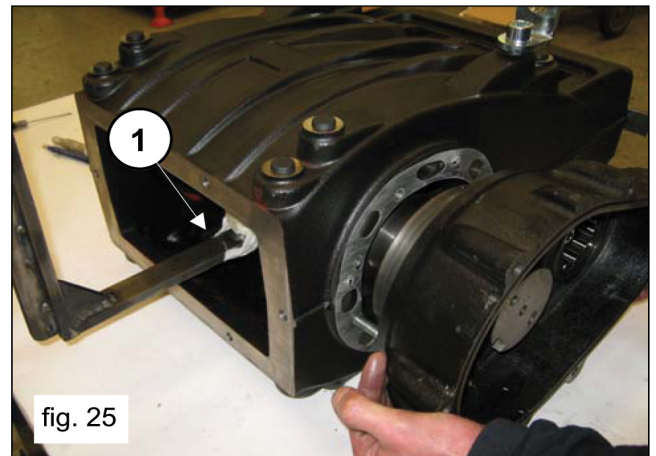
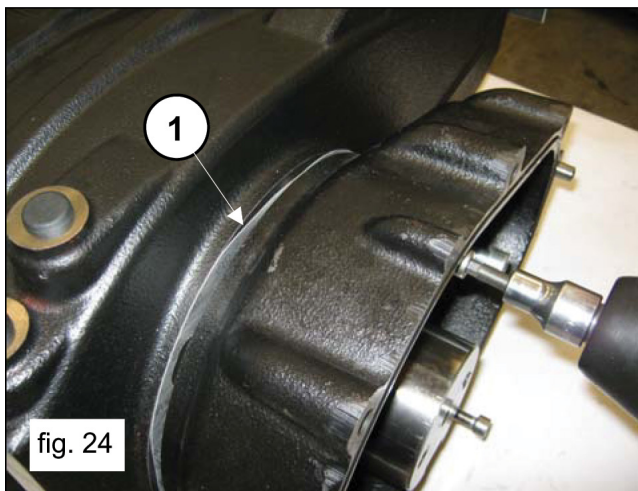
Unscrew the reduction gear box fixing screws (1, fig. 22).



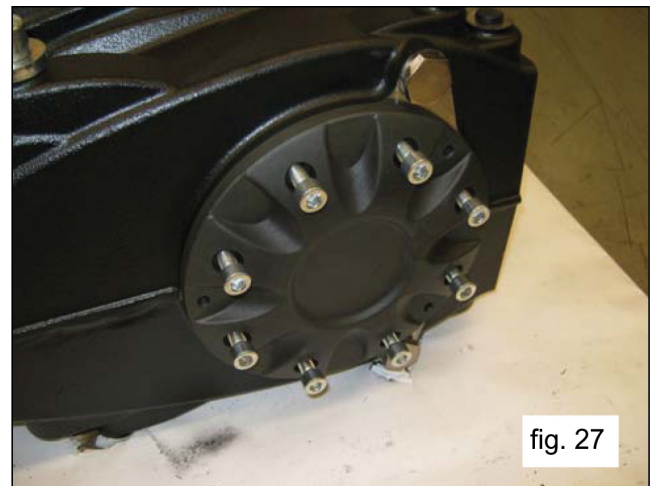
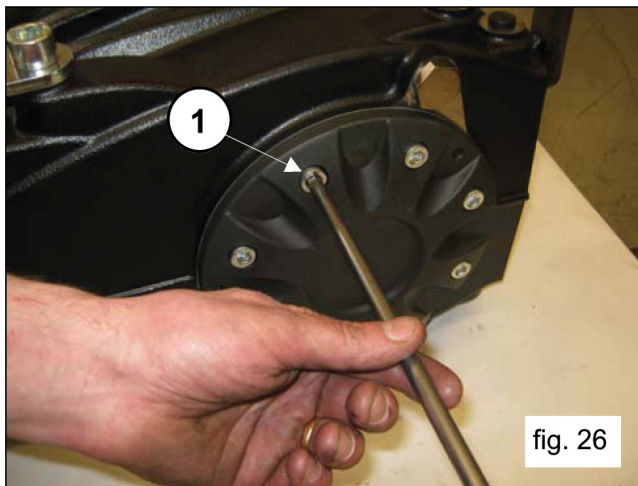
Position the 3 grub screws or M8 threaded screws (1, fig. 23) with the function of extractors in the holes and two sufficiently long M10 screws with the function of supporting the reduction gear box (2, fig. 23).



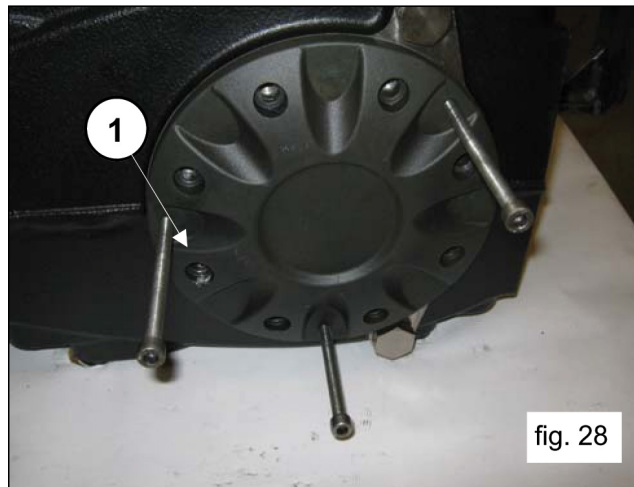
Slowly screw in the 3 M8 screws (1, fig. 24) to prevent the box from tilting too far and getting locking in the housing. Remove the box while supporting the shaft to prevent damage (1, fig. 25)



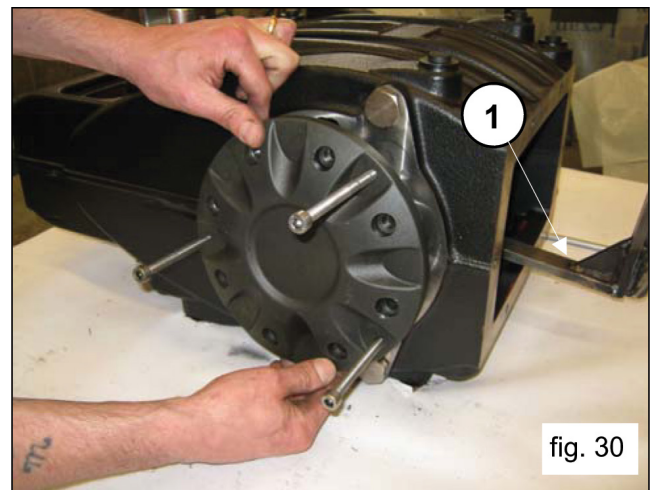
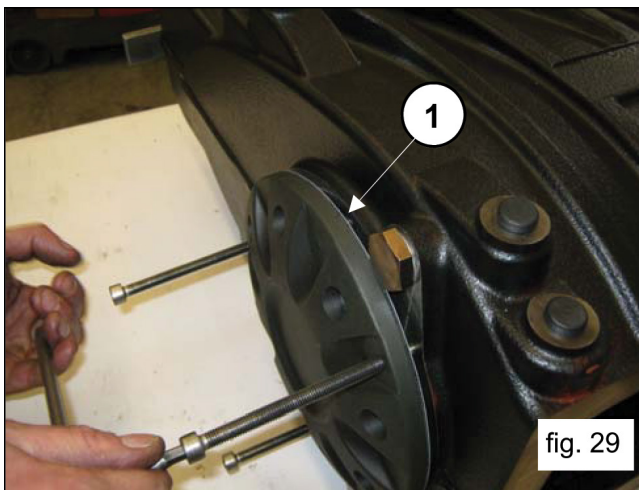
Unscrew the bearing cover fixing screws from the opposite side (1, fig. 26 and fig. 27).



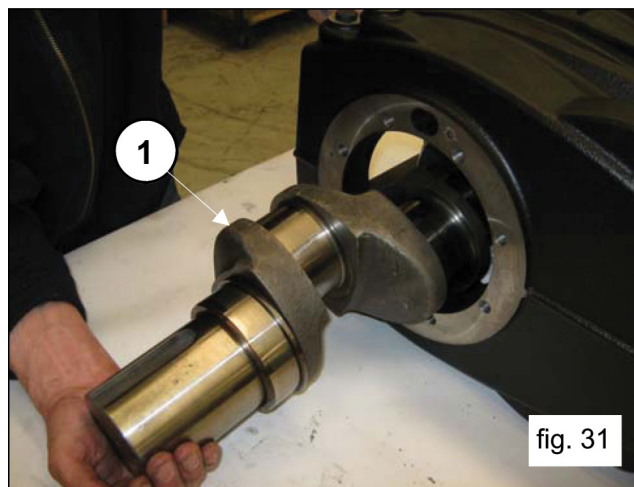
Position the 3 grub screws or M8 threaded screws (1, fig. 28) with the function of extractors in the holes.



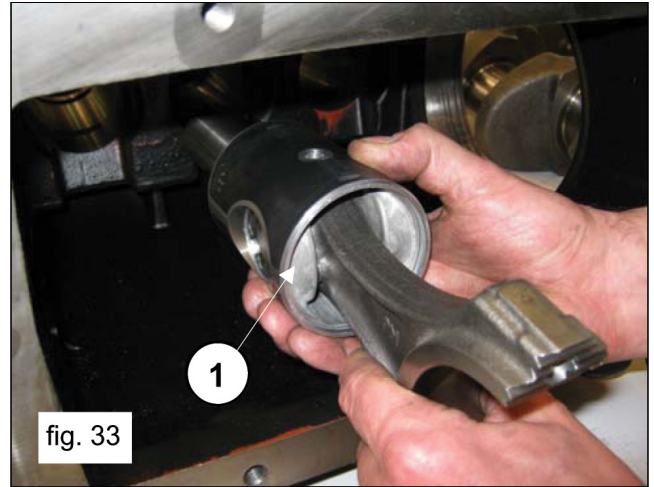
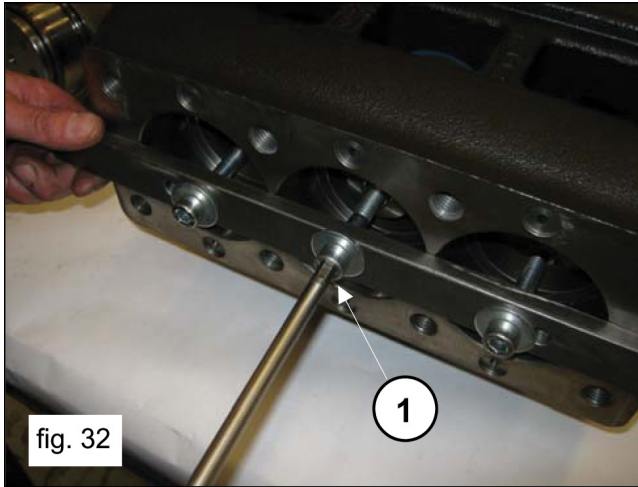
Slowly screw in the 3 M8 screws (1, fig. 29) to prevent the cover from tilting too far and getting locked in the housing. Remove the bearing cover while supporting the shaft to prevent damage (1, fig. 30).



Remove the crankshaft from the PTO side (1, fig. 31)



In the event that it is necessary to replace one or more con-rods or plunger guides, operate as follows: Unscrew the screws with tool #F27566200 to unlock the con-rods (1, fig. 32) and then extract the con-rod plunger guide units from the back casing opening (1, fig. 33).

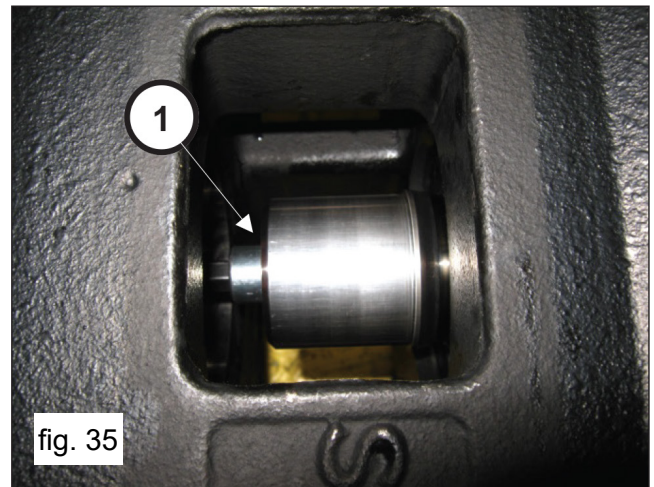
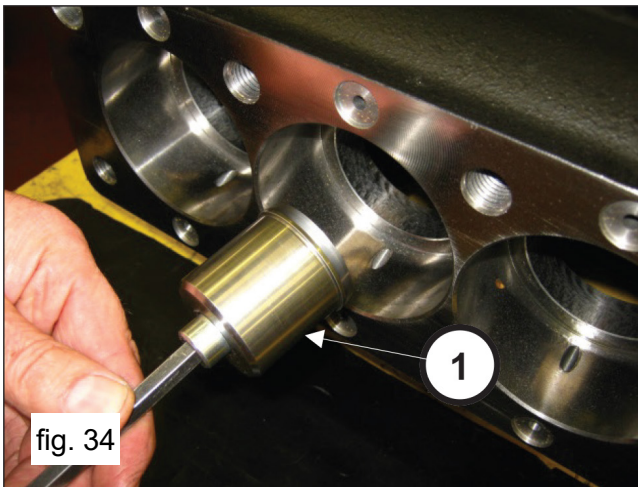


It is now possible to disassemble the plunger guide seal rings, taking care to not damage the plunger guide sliding rod.

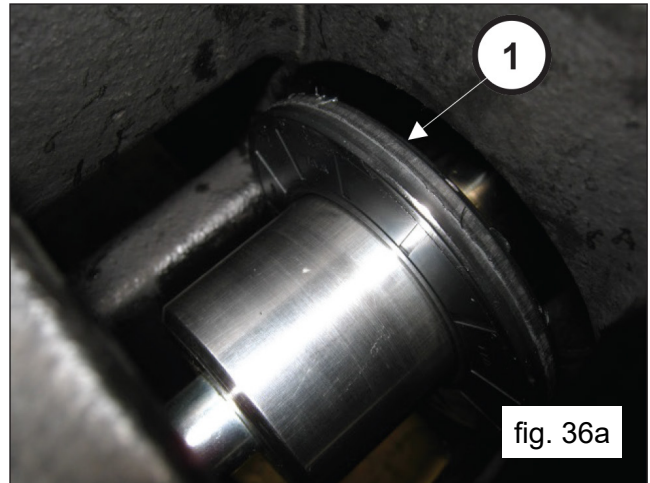


Whenever it becomes necessary to replace the plunger guide seal rings without dismantling the entire mechanical part, it is possible to extract the seal rings with the use of tool #F27644300 operating as follows:

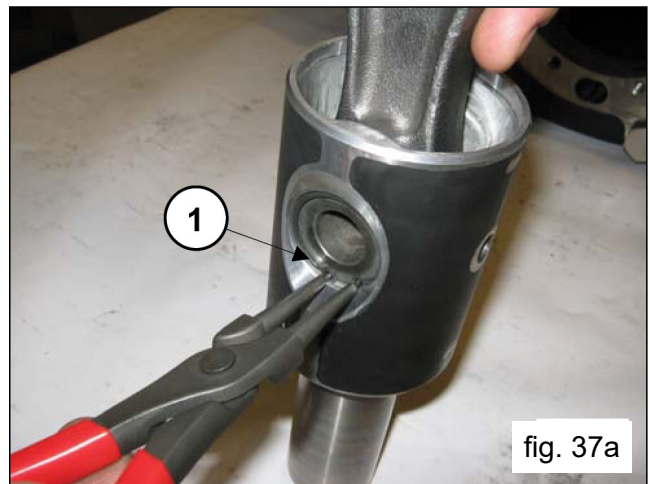
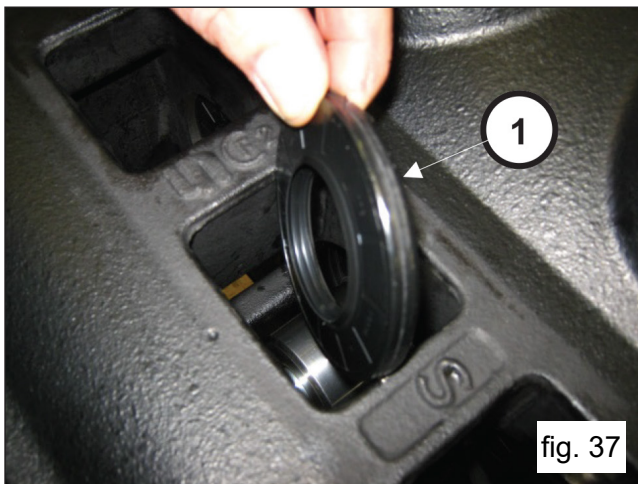
Insert the tool (1, fig. 34) and screw it on the stem until it stops (1, fig. 35).



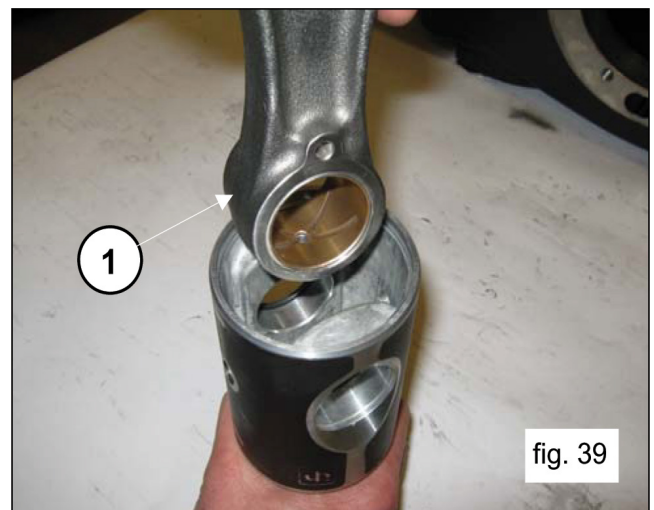
Insert until the tool teeth enters completely into the oil seal (1, fig 36). Continue rotating the tool until the oil seal is completely removed (1, fig 36a).



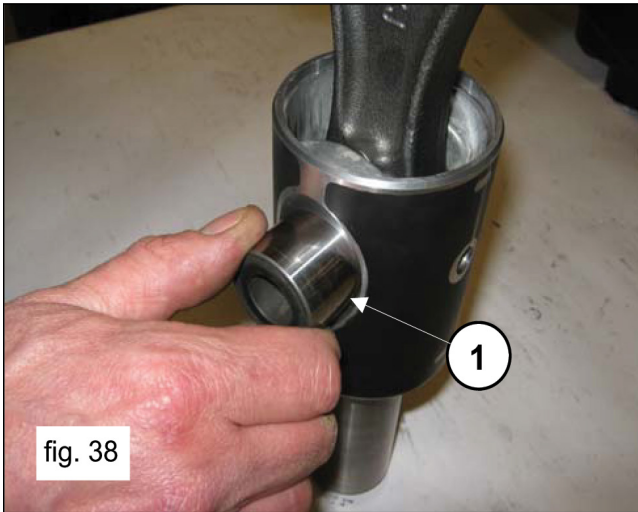
Remove the tool and remove the oil seal (1, fig. 37)
Remove the two spindle locking Seeger rings (1, fig. 37a)



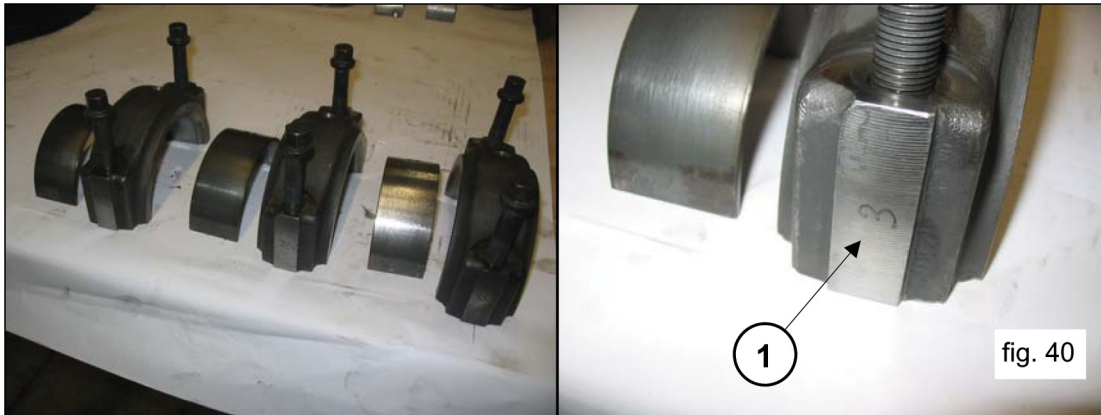
Remove the spindle (1, fig. 38) and extract the con-rod (1, fig. 39).



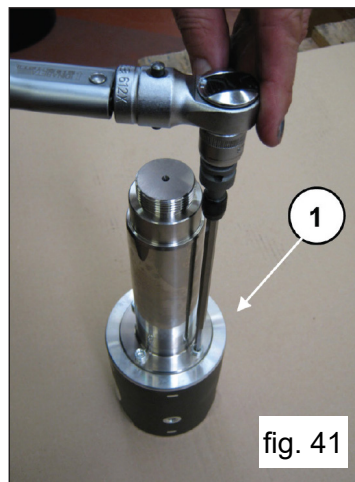
Remove the spindle (1, fig. 38) and extract the con-rod (1, fig. 39).



Couple the half supports to the previously disassembled caps, referring to the numbering (1, fig. 40).



To separate the rod from the plunger guide, unscrew the round head M6 screws (1, fig. 41).

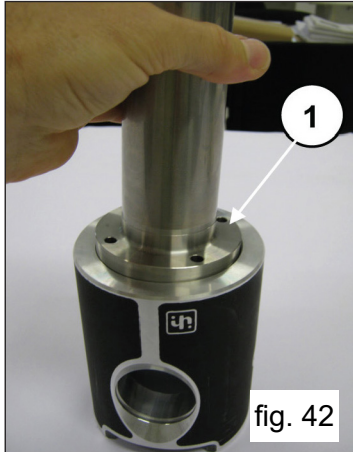


2.1.2 Assembly of Mechanical Parts

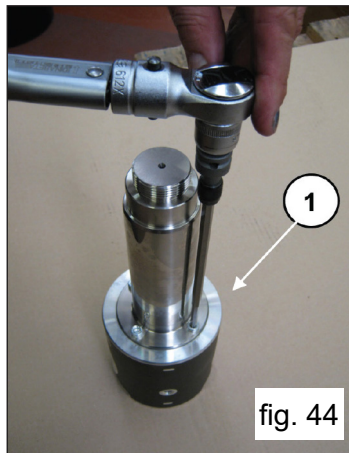
Proceed with assembly following the reverse order indicated in point 2.1.1. The proper sequence is as follows:

Assemble the red to the piston guide.

Insert the plunger guide rod into its seat on the plunger guide (1, fig. 42) and join the rod to the plunger guide by means of the 4 M6x20 screws (1, fig. 43).



Lock the piston guide in a vice with the aid of a special tool and calibrate the screws with a torque wrench (1, fig. 44) as indicated in paragraph 3 “Screw Tightening Calibration”.



Insert the con-rod in the plunger guide (1, fig. 39) and then insert the spindle (1, fig. 38). Apply the two shoulder retaining rings (1, fig. 37).



Assembly has been carried out properly if the con-rod foot, plunger guide and spindle rotate freely.

Separate the caps from the half supports. Proper coupling can be verified by the numbering on the side (1, fig. 40).

After having checked casing cleaning, proceed with assembly of half support-plunger guide unit inside casing rods (1, fig. 33).



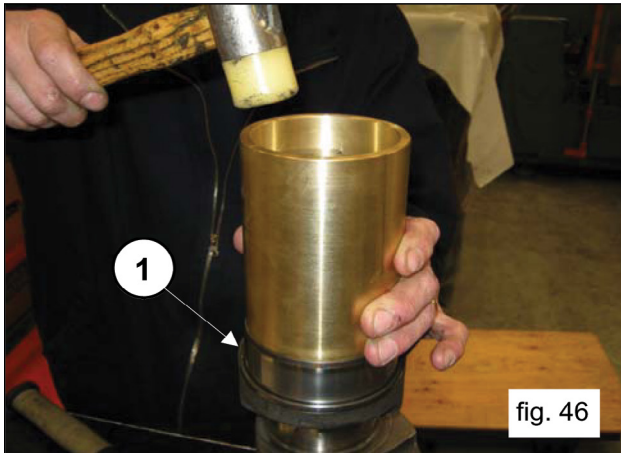
Insertion of the half support-plunger guide unit in the casing must be made with the half bearings set in the direction in which numbers are visible from above.

Block the three units with the use of special tool #F27566200 (1, fig. 32).

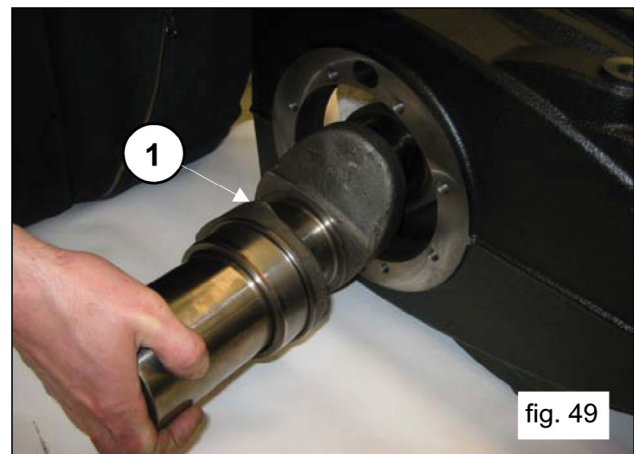
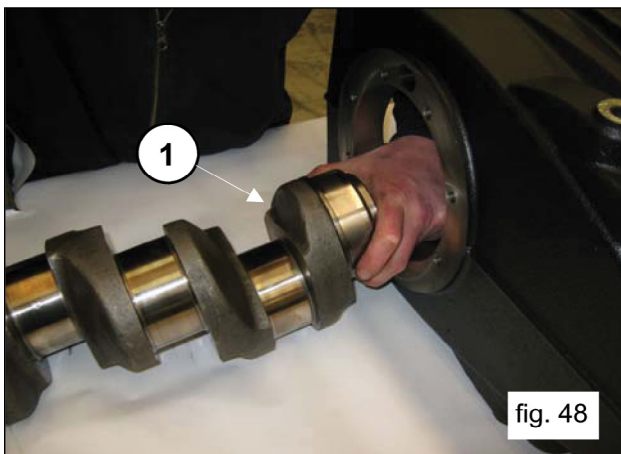
Pre-assemble the ring inside the crankshaft bearings (on both sides of the shaft down to the stroke) using special tool #F27604700 (1, fig. 46) (1, fig. 47).



The inner and outer rings of the bearings must be reassembled keeping the same coupling with which they were disassembled.



Insert the shaft from the PTO side, taking care not to hit the previously assembled con-rod shanks (1, fig. 48) and (1, fig. 49).



The crankshaft must always be assembled with the PTO on the opposite side with respect to the 1/2" NPT holes for the oil discharge plugs on the pump casing (1, fig. 51).

Fully insert the shaft in the casing (1, fig. 50 and fig. 51).

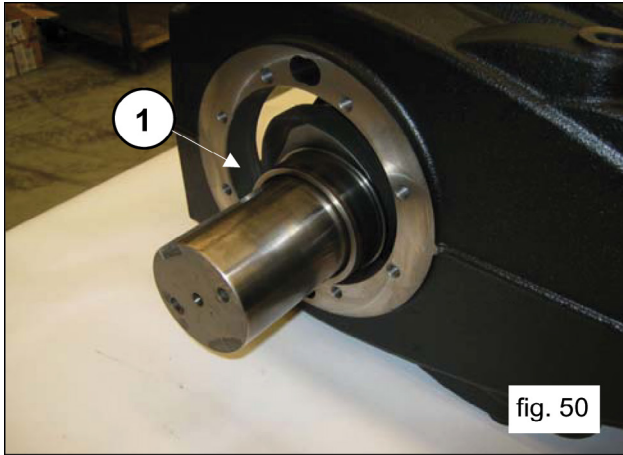


fig. 50

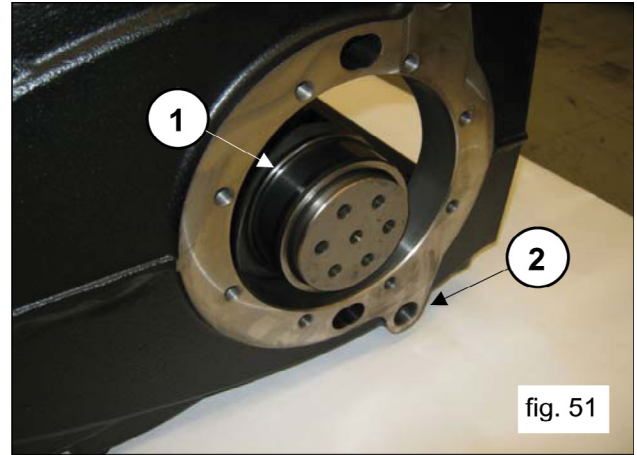


fig. 51

Pre-assemble the outer ring of the pinion bearing on the reduction gear with the aid of special tool #F27604900 (1, fig. 52), inserting fully down to end stroke (1, fig. 53).

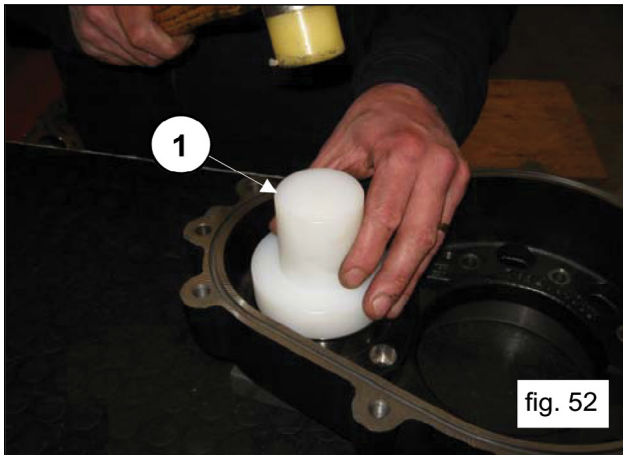


fig. 52

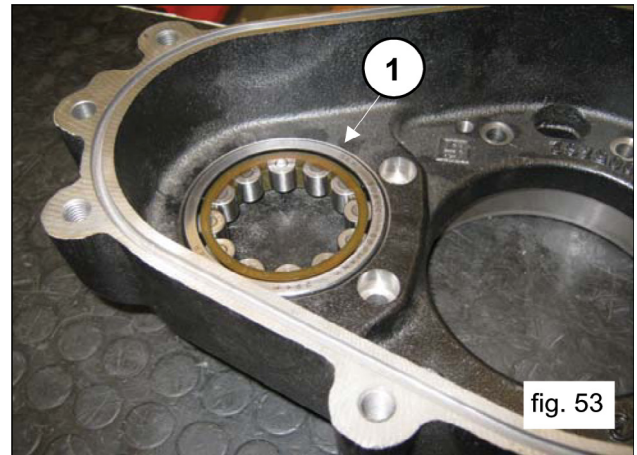


fig. 53

From the opposite side of the reduction gear box, pre-assemble the external ring of the crankshaft bearing with the use of tool #F27605000 (1, fig. 54), inserting fully down to end stroke (1, fig. 55).

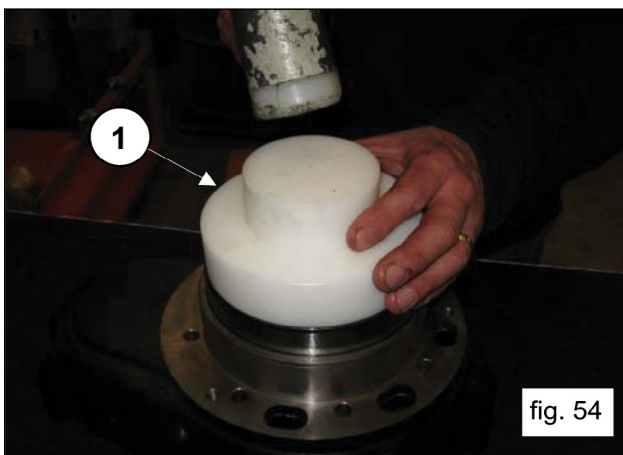


fig. 54

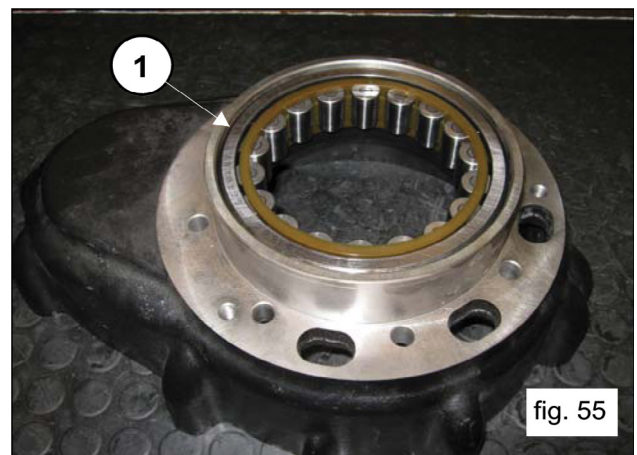
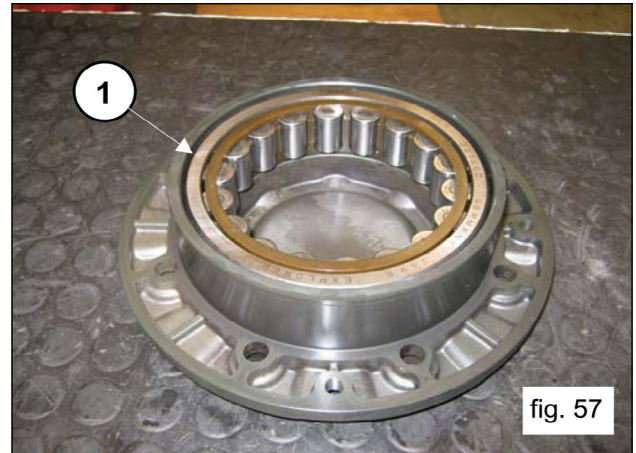
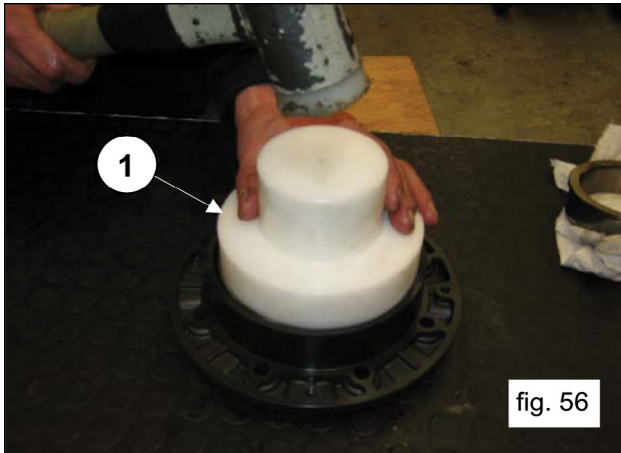
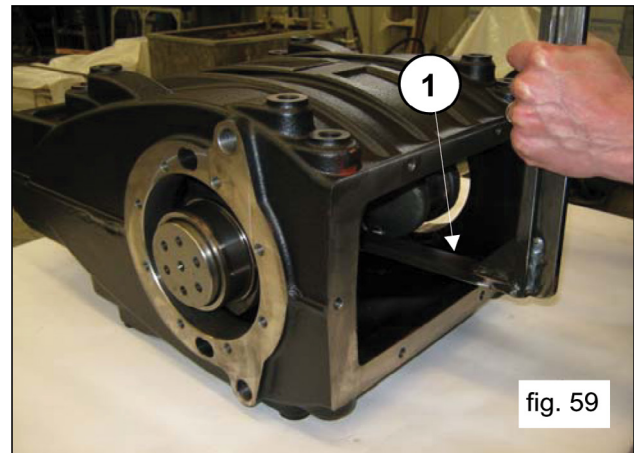


fig. 55

Repeat this operation on the bearing box, pre-assembling the external crankshaft bearing ring with the help of special tool #F27605000 (1, fig. 56), inserting fully down to end stroke (1, fig. 57).



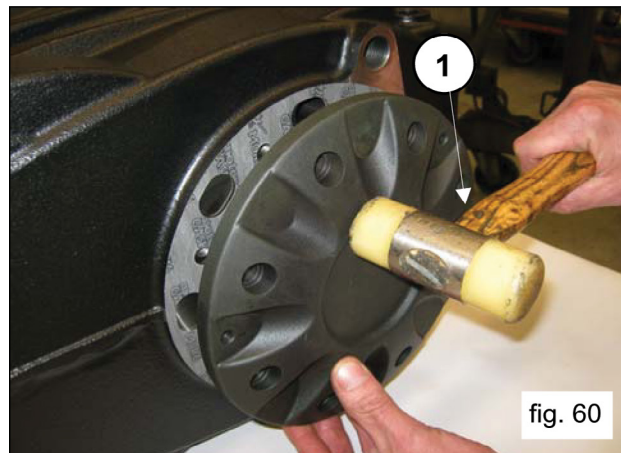
Insert the side seal on the bearing cover (1, fig. 58) and lift the crankshaft to favor cover insertion (1, fig. 59).



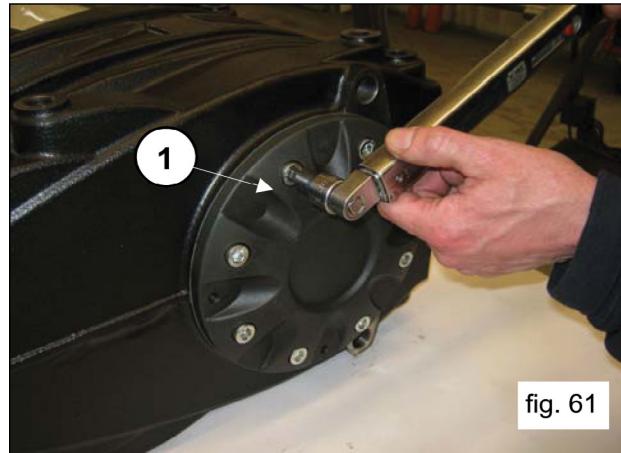
Assemble the bearing cover (and relative seal) using an extractor hammer (1, fig. 60).



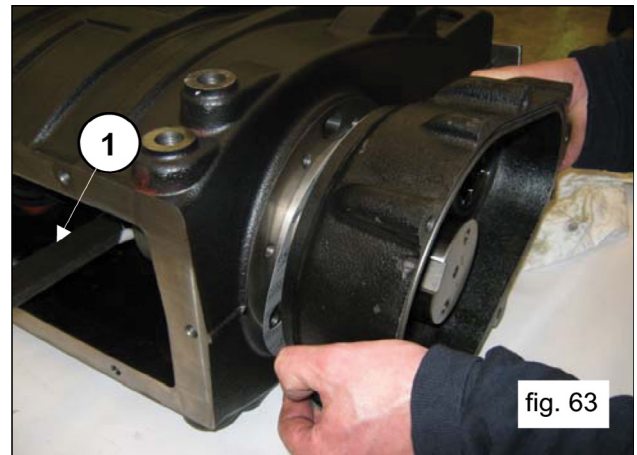
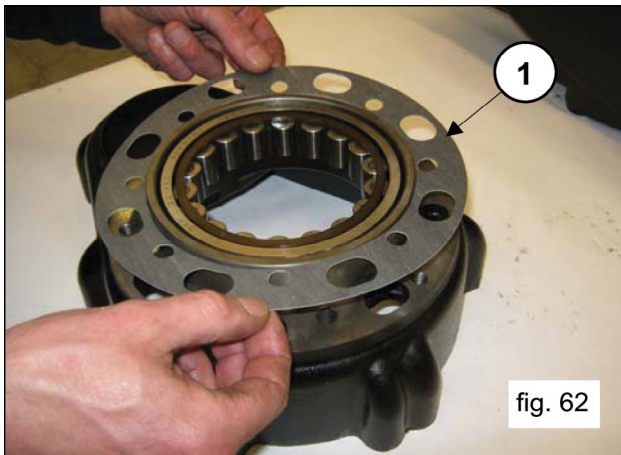
Position the bearing cover in such a way that the “Pratissoli” logo is perfectly horizontal.



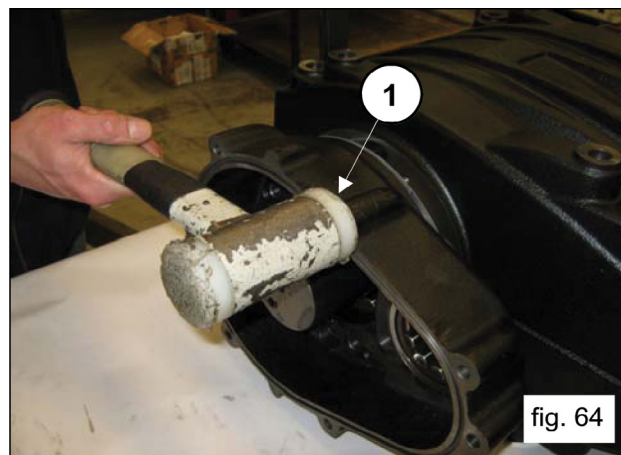
Tighten the 8 M10 x 30 screws (1, fig. 61). Calibrate the screws with a torque wrench as indicated in paragraph 3 "Screw Tightening Calibration".



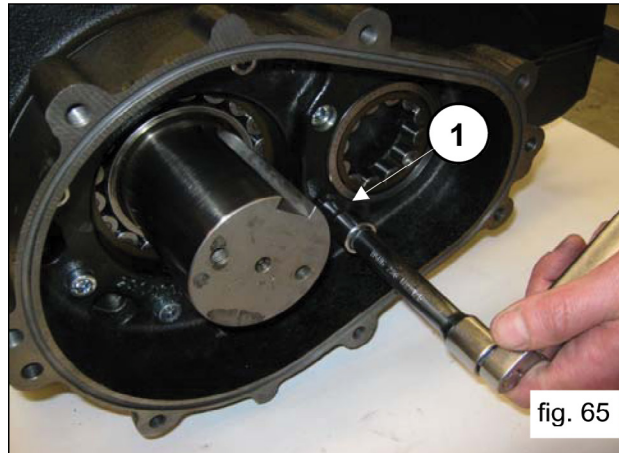
From the opposite side, insert the side seal on the reduction gear box 91, fig. 62) and lift the crankshaft to favor cover insertion (1, fig. 63).



Assemble the reduction gear box (and relative seal) using an extractor hammer (1, fig. 64).



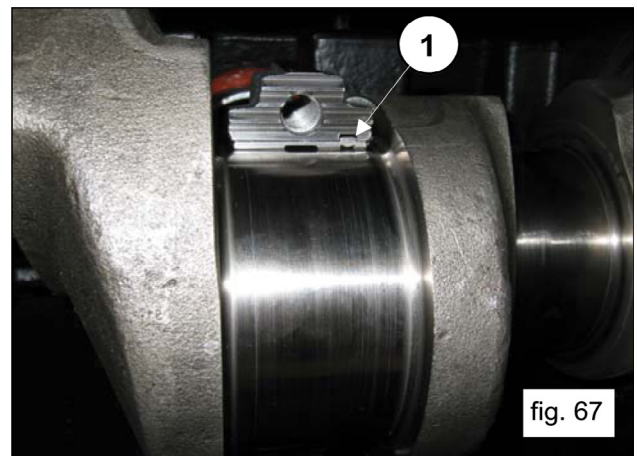
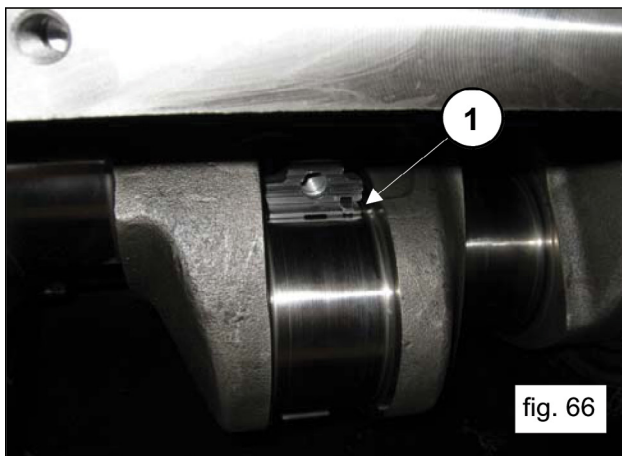
Tighten the 8 M10 x 40 screws (1, fig. 56). Calibrate the screws with a torque wrench as indicated in paragraph 3 “Screw Tightening Calibration”.



Remove the tool for blocking the con-rods #F27566200 (1, fig. 32). Insert the upper half-bearings between the con-rods and the shaft (1, fig. 66).



For proper assembly of the half-bearings, ensure that the reference tab on the half-bearings are positioned in their housing on the half support (1, fig. 67).



Apply the lower half-bearings to the caps (1, fig. 68) ensuring that the half-bearing reference notches are positioned in their housing on the cap (1, fig. 68).

Fasten the caps to the half supports by means of M10 x 1.5 x 80 screws (1, fig. 69).



Note the correct assembly direction of the caps. Numbering must be turned upward.

Calibrate the screws with a torque wrench as indicated in paragraph 3 “Screw Tightening Calibration), bringing the screws to tightening torque at the same time.

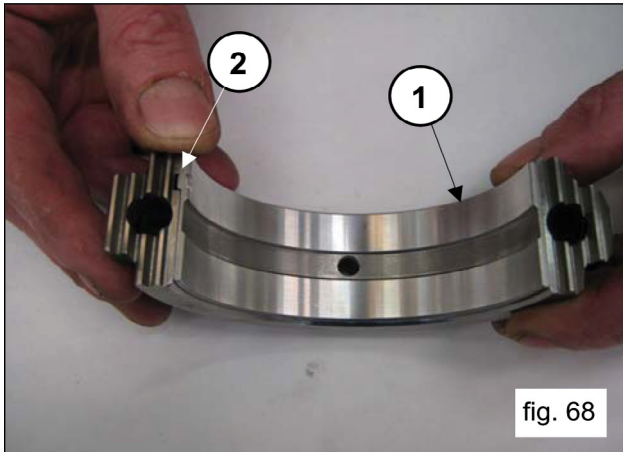


fig. 68

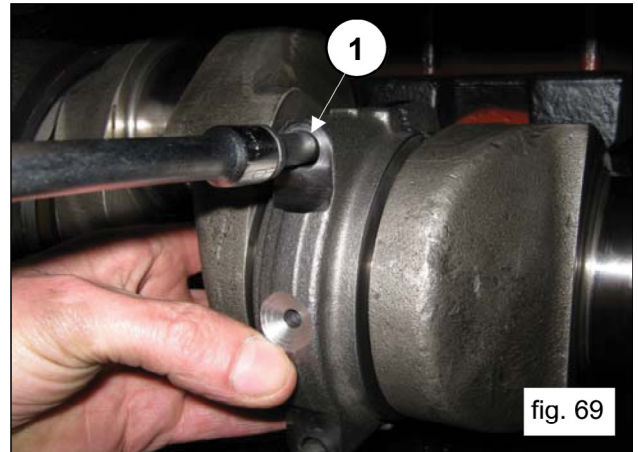


fig. 69



After finishing this operation, verify that the con-rods have axial clearance in both directions.

Insert the plunger guide seal rings in their casing housing by means of a special tool #F27605300 and F27634400 (1, fig. 70) (2, fig. 70a).

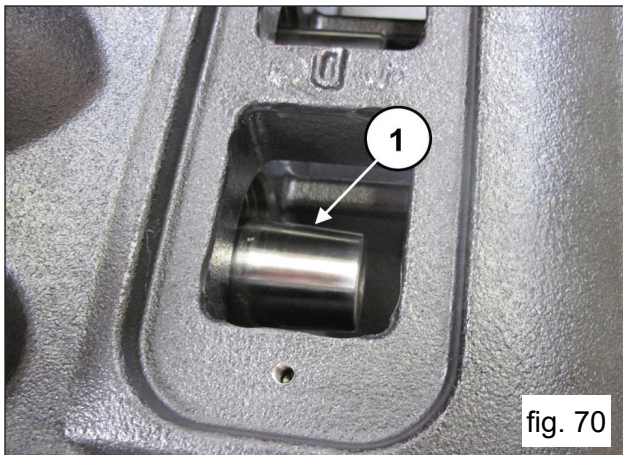


fig. 70

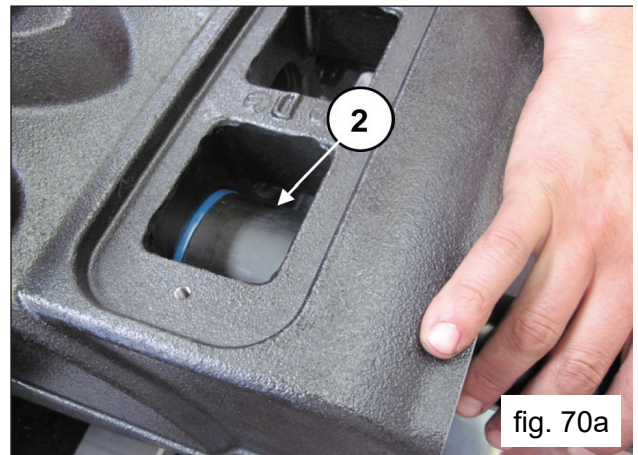


fig. 70a

Insert the O-ring on the rear cover (1, fig. 71) and assemble the cover on the casing with the aid of 6 M10 x 30 screws (1, fig. 72).

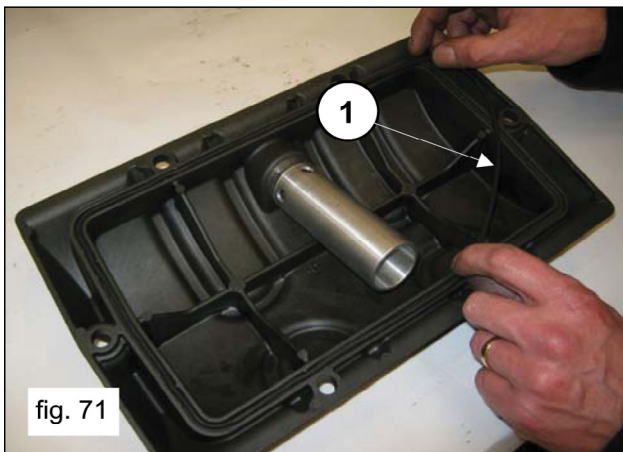


fig. 71

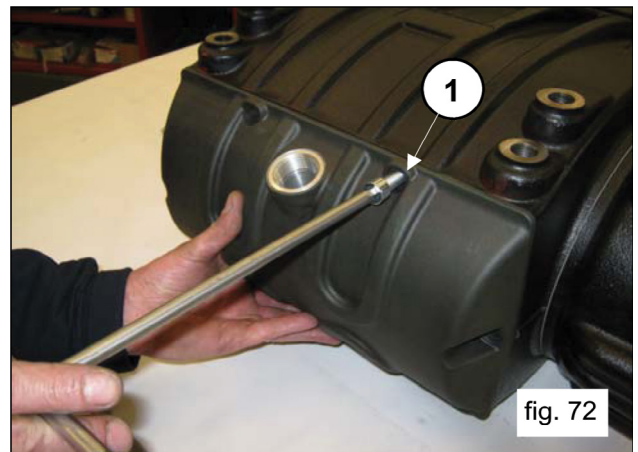


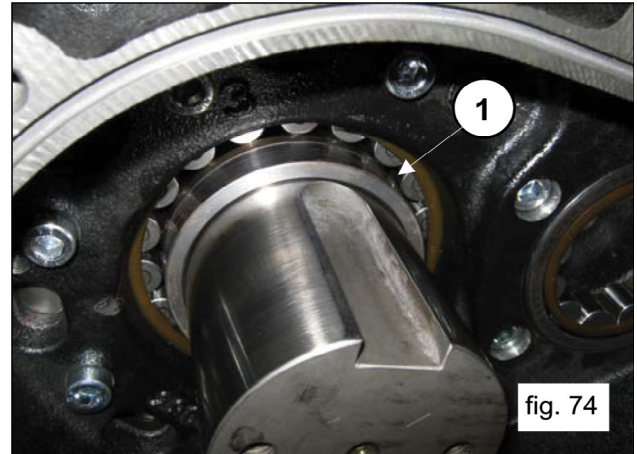
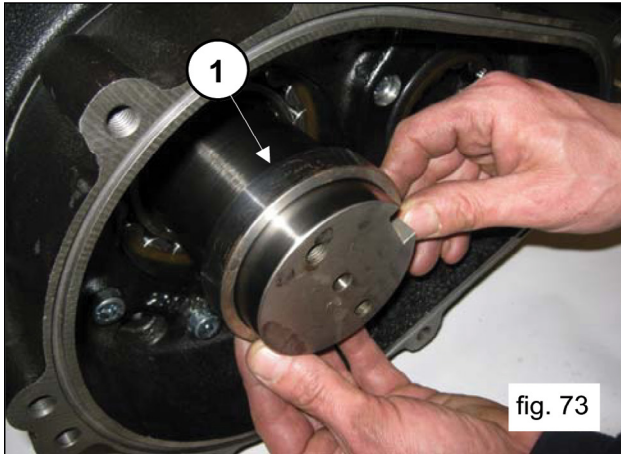
fig. 72



Take care to fully and properly insert the O-ring in its housing on the cover to prevent damage during screw tightening.

Calibrate the screws with a torque wrench as indicated in paragraph 3 "Screw Tightening Calibration".

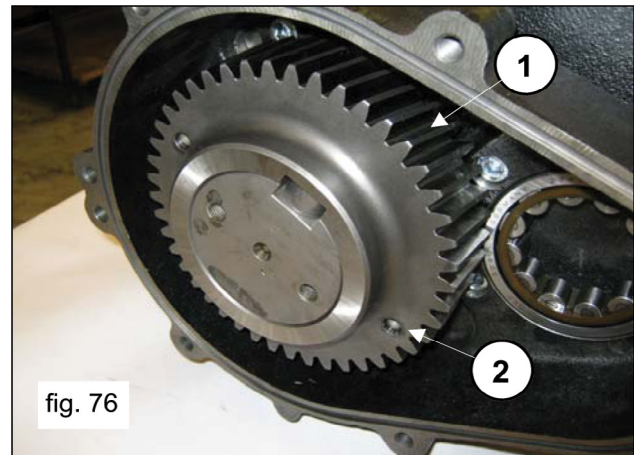
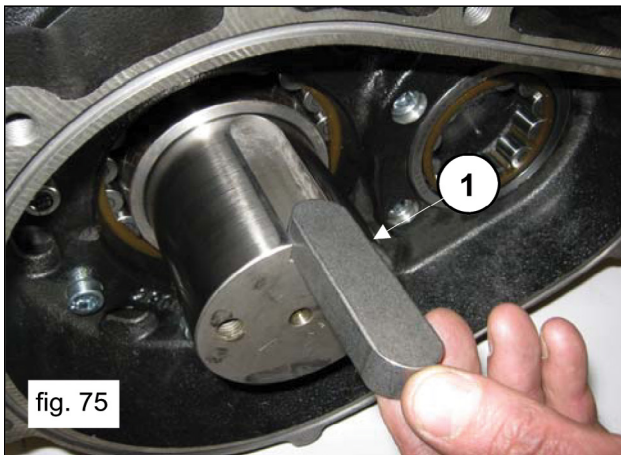
Insert the ring gear support ring in the crankshaft shank (1, fig. 73) to end stroke (1, fig. 74).



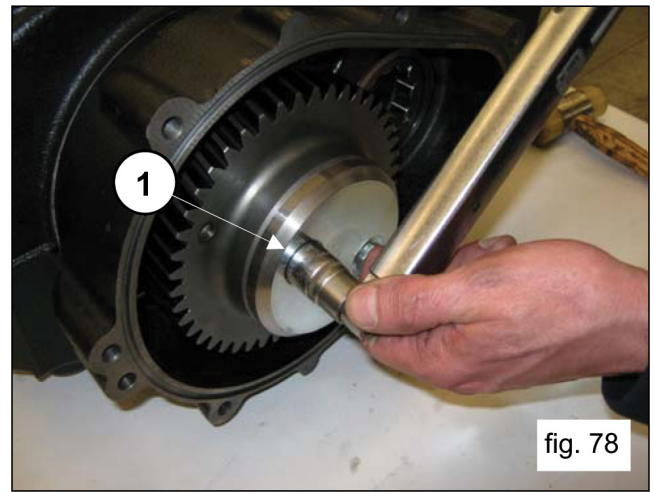
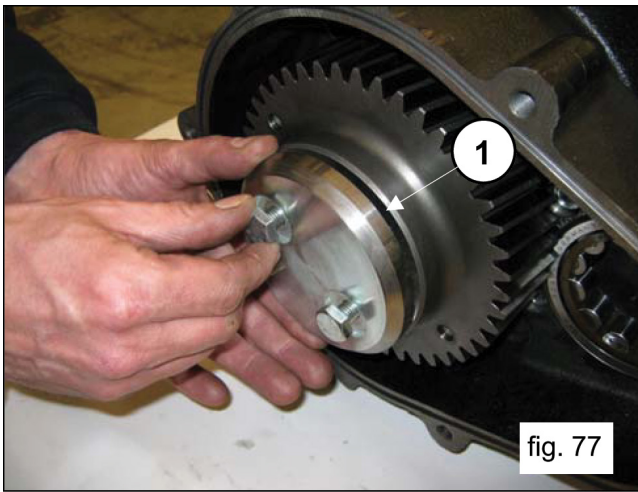
Apply key 22 x 14 x 80 in the shaft housing (1, fig. 75) and insert the ring gear on the shaft (1, fig. 76).



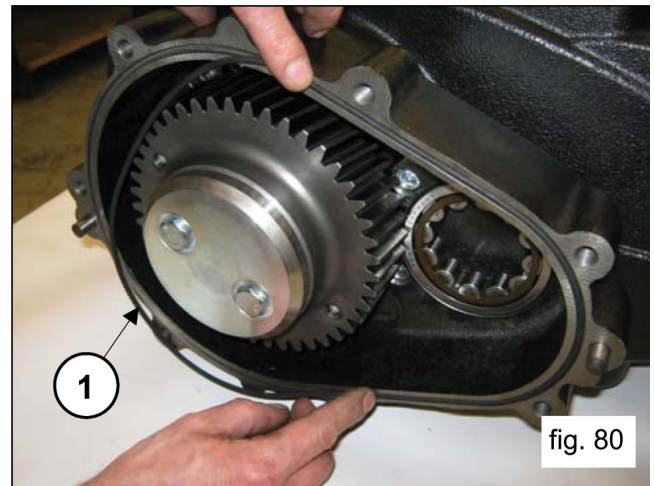
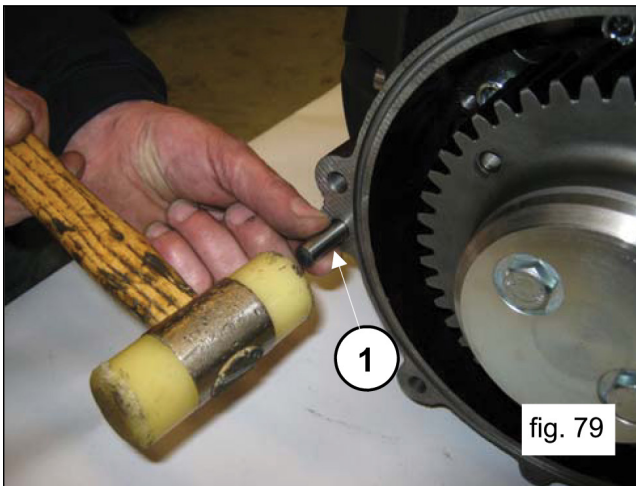
The ring gear must be assembled making sure that the two M8 holes (to be used for extraction) be turned outward of the pump (1, fig. 76).



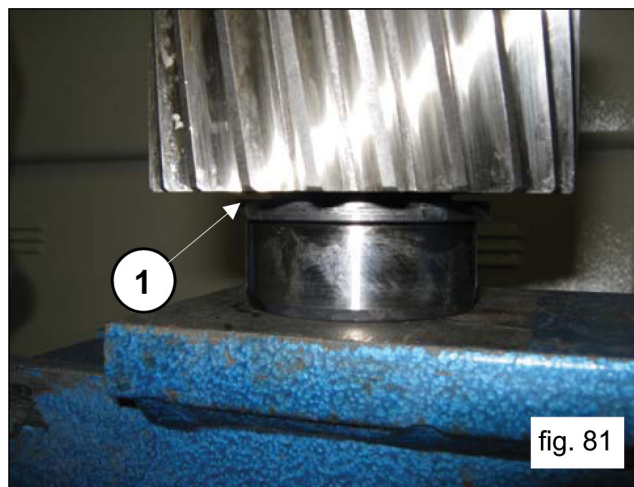
Fasten the ring gear stop (1, fig. 77) using 2 M10 x 25 screws. Calibrate the screws with a torque wrench as indicated in paragraph 3 "Screw Tightening Calibration" (1, fig. 78).



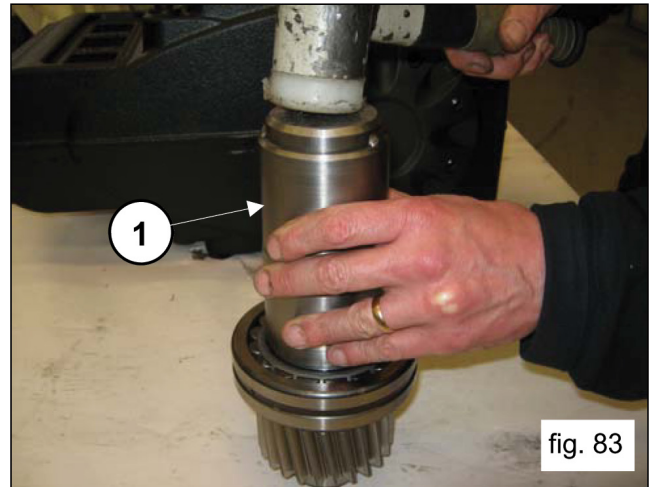
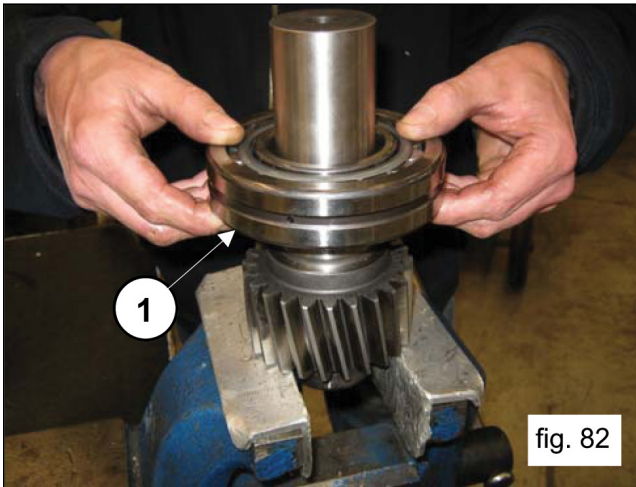
Apply the two Ø10 x 24 pins on the reduction gear box (1, fig. 79) and insert the O-ring (1, fig. 80).



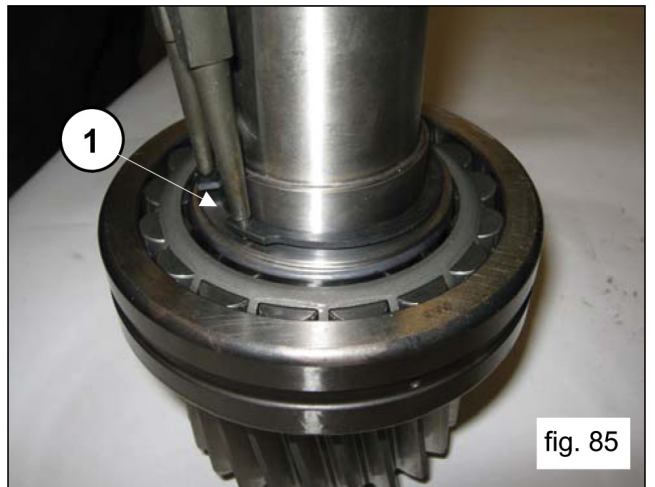
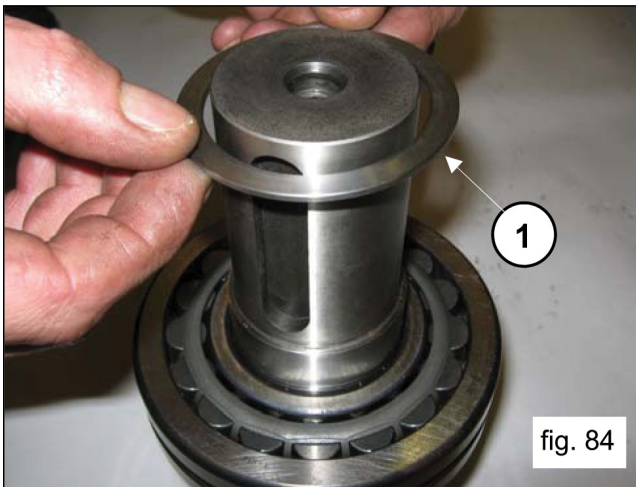
Complete assembly of the pinion on the reduction gear cover, proceeding as follows:
Pre-assemble the inner bearing ring 40 x 90 x 23 on the pinion (1, fig. 81) positioning it to end stroke.



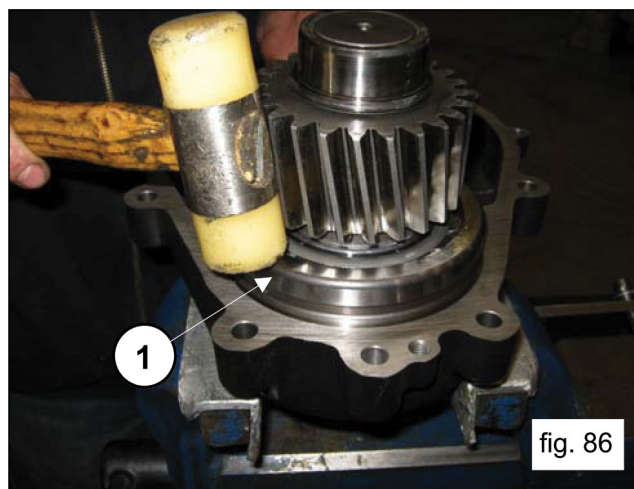
From the other side of the pinion, pre-assemble the bearing 55 x 120 x 29 (1, fig. 82) positioning it to end stroke using tool #F27604800 (1, fig. 83).



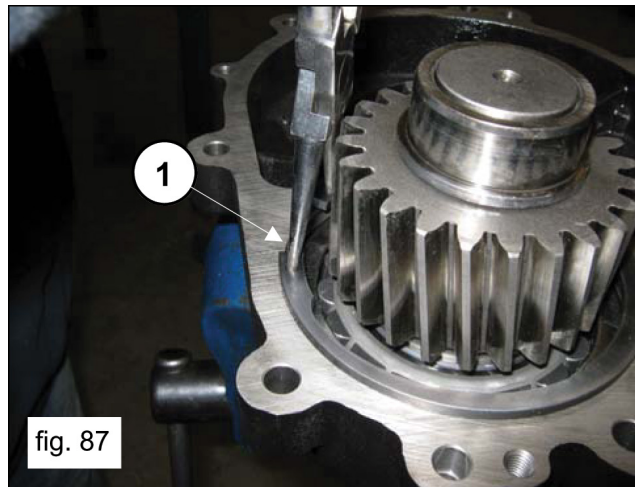
Insert the bearing support ring (1, fig. 84) and position the retaining ring Ø55 (1, fig. 85).



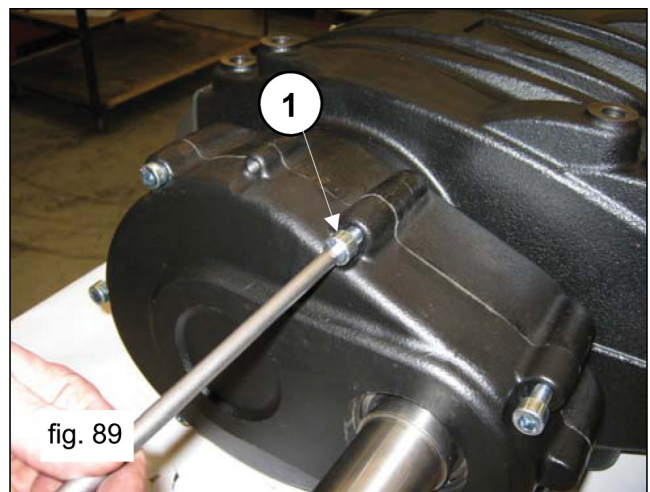
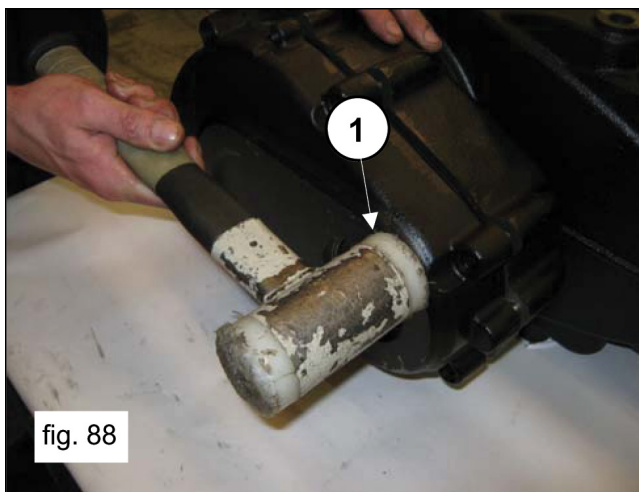
Insert the pinion pre-assembled inside its housing in the reduction gear cover, with the aid of an extractor hammer (1, fig. 86).



Insert the retaining ring Ø120 in the housing (1, fig. 87).



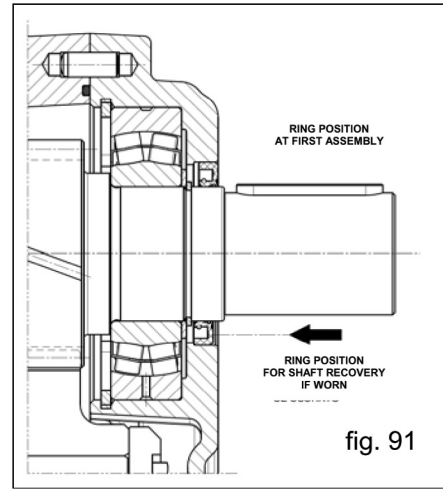
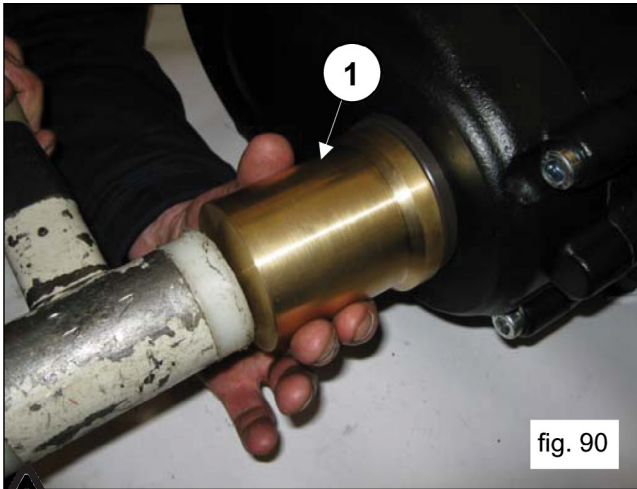
Assemble the reduction gear cover with the aid of an extractor hammer (1, fig. 88) and fasten them with 7 M10 x 40 screws (1, fig. 89). Take care to properly couple the two components on the bearing 40 x 90 x 23. Calibrate the screws with a torque wrench as indicated in paragraph 3 "Screw Tightening Calibration".



Insert the seal ring inside the reduction gear cover with the use of special tool #F27605200 (1, fig. 90). Before proceeding with seal ring assembly, check lip seal conditions. If replacement is necessary, position the new ring on the bottom of the groove as indicated in fig. 91.

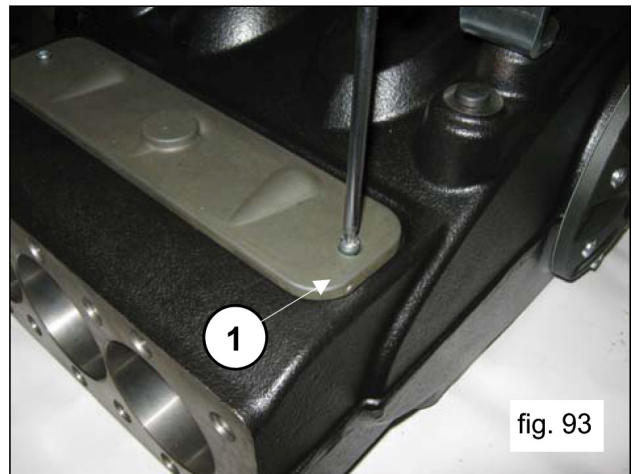
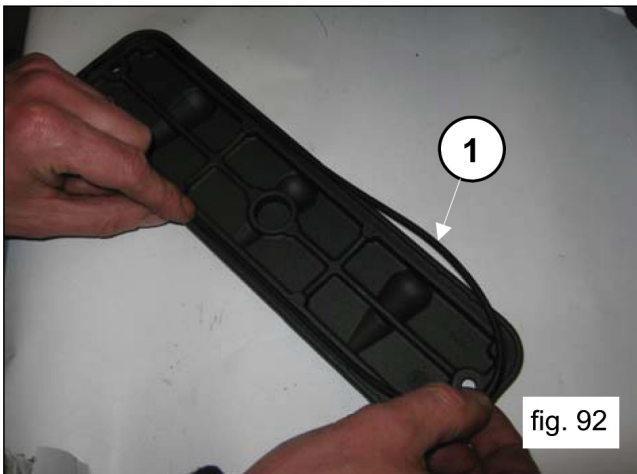


If the shaft should present a diameter wear corresponding to the lip seal, to prevent grinding, position the ring in the second stroke as indicated in fig. 91.

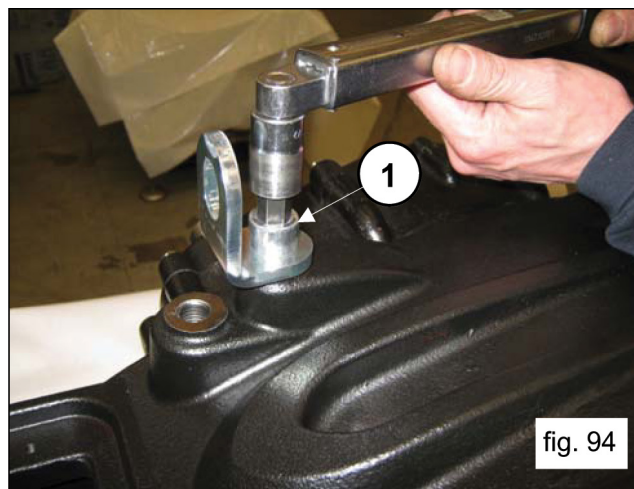


To prevent damage to the seal ring, take special care when inserting the seal ring on the pinion.

Apply O-rings on the inspection covers (1, fig. 92) and tighten with 2+2 M16 x 14 screws (1, fig. 93). Calibrate the screws with a torque wrench as indicated in paragraph 3 "Screw Tightening Calibration".



Insert the key 14 x 9 x 60 on the pinion. Apply plugs and lifting brackets with the use of M16 x 30 screws (1, fig. 94). Calibrate the screws with a torque wrench as indicated in paragraph 3 "Screw Tightening Calibration".



Insert oil in the casing as indicated in the use and maintenance manual point 7.4

2.1.3 Increase and Reduction Classes

TABLE OF REDUCTIONS FOR CRANKSHAFTS AND CON-ROD HALF-BEARINGS

Recovery classes (mm)	P/N Half-bearing Upper	P/N Half-bearing Lower	Correction on the shaft pin diameter (mm)
0.25	F90928100	F90928400	Ø79.75 0/0.02 Ra 0.4 Rt 3.5
0.50	F90928200	F90928500	Ø79.50 0/0.02 Ra 0.4 Rt 3.5

INCREASE TABLE FOR PUMP CASING AND PLUNGER GUIDE

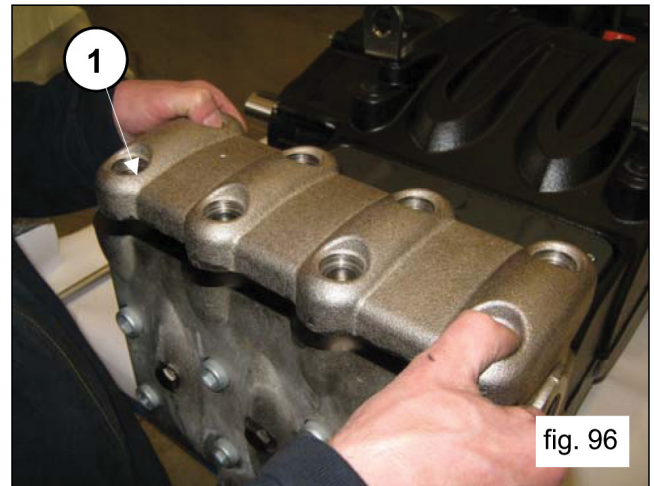
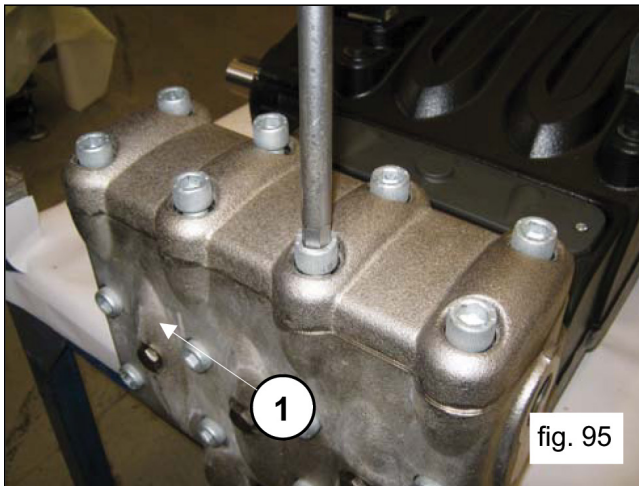
Recovery classes (mm)	P/N Plunger Guide	Adjustments on the Pump Casing housing (mm)
1.00	F73050243	Ø71 H6 +0.019/0 Ra 0.8 Rt 6

2.2 Repairing Hydraulic Parts

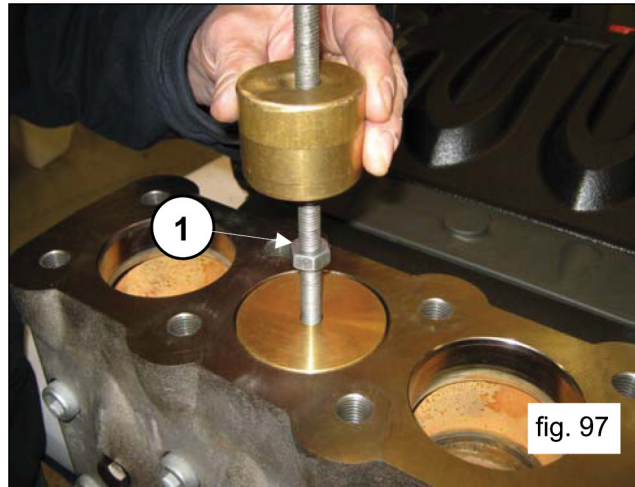
2.2.1 Dismantling the MW32A, MWS36A, MWS40A Head-Valve Units

The head requires preventive maintenance as indicated in the use and maintenance manual. Operations are limited to inspection or replacement of valves, if necessary. Proceed as follows to extract valve groups:

Unscrew the 8 M16 x 55 screws of the valve cover (1, fig. 95) and remove the cover (1, fig. 96).



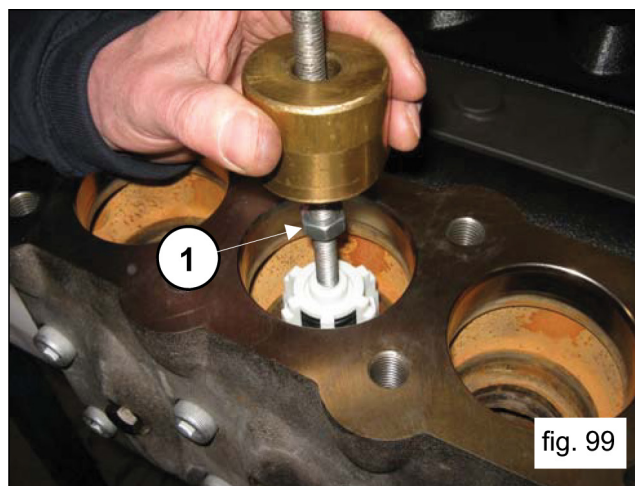
Extract the valve plug with the use of an extractor hammer to be applied on the M10 hole of the valve plug (1, fig. 97).



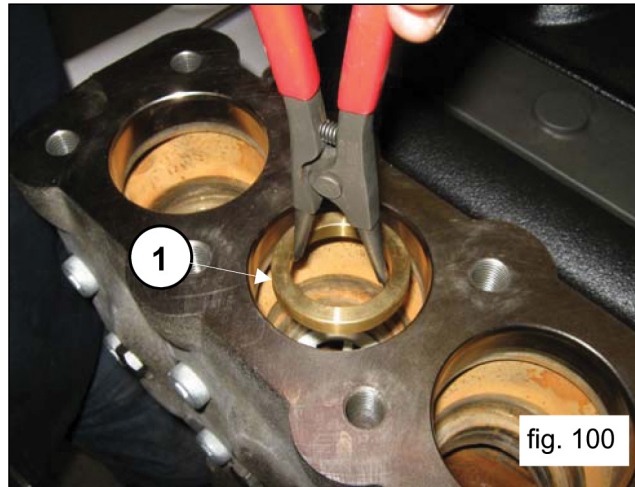
Remove the spring (1, fig. 98).



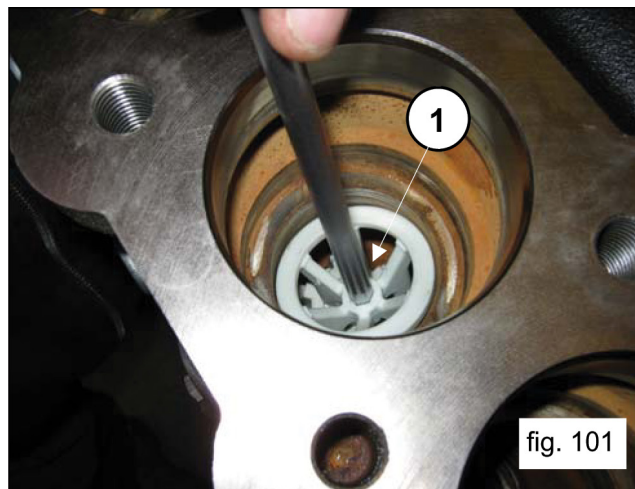
Extract the outlet valve unit with the use of an extractor hammer (p/n F27516400) to be applied on the M10 hole of the valve guide (1, fig. 99).



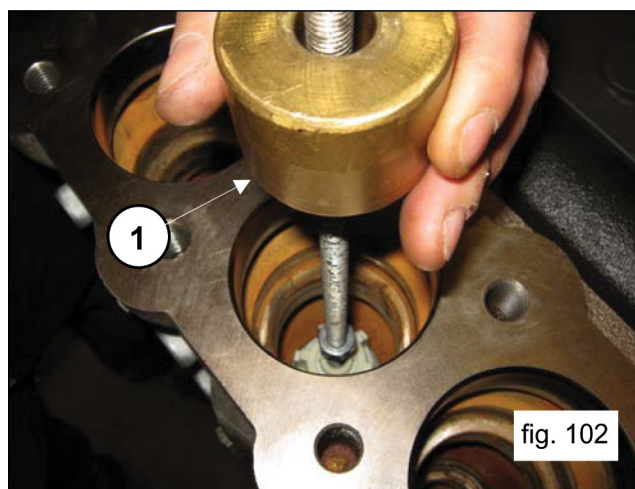
Remove the valve housing spacer ring (1, fig. 100).



Remove the valve guide spacer inserting 8mm hexagon spanner in the housing and lifting it to facilitate removal (1, fig. 101).

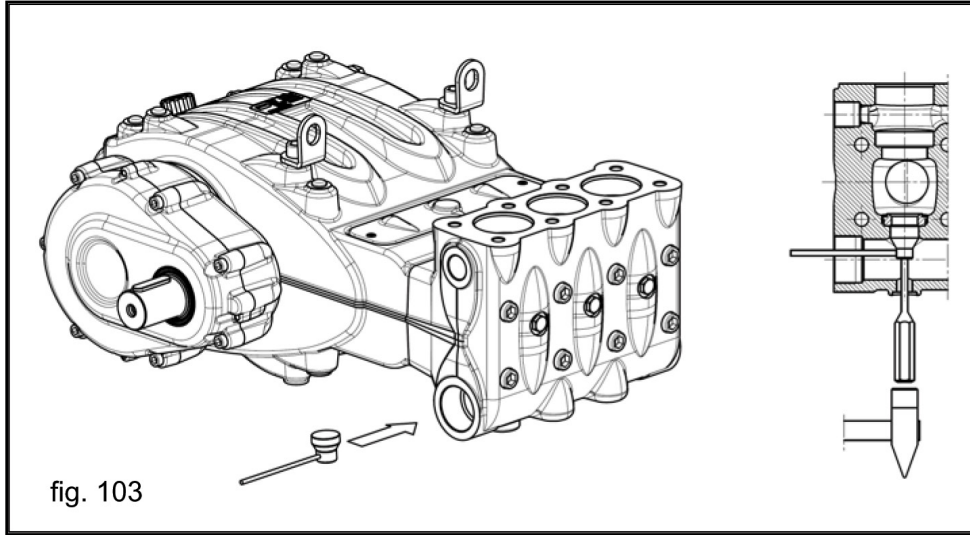


Extract the suction valve unit with the use of an extractor hammer (#F27516400) to be applied on the M10 hole of the valve guide (1, fig. 102).

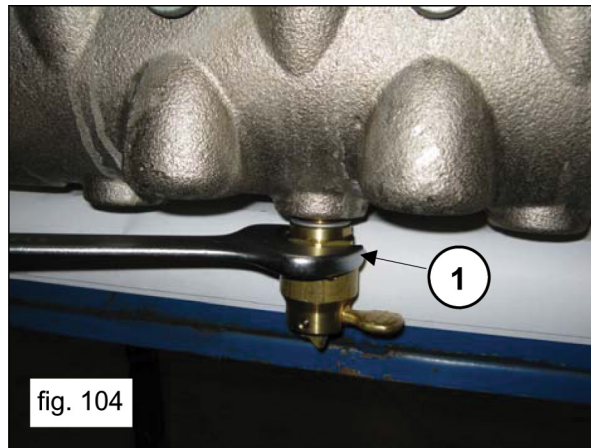




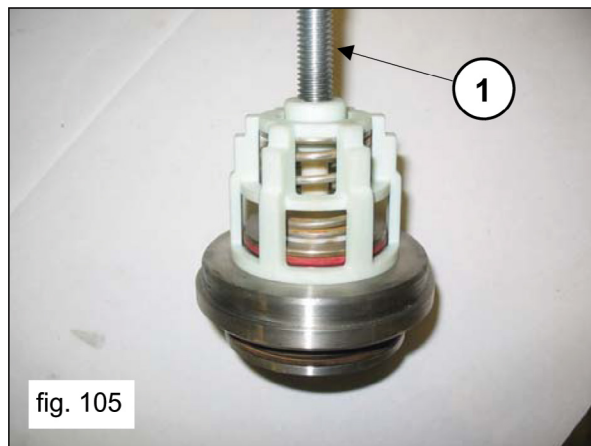
Where extraction of the suction valve unit is especially difficult (i.e. incrustations due to prolonged lack of use), use an extractor tool #F27516200 (1, fig. 103) as indicated.



Unscrew the valve opening device by means of a 30mm spanner (1, fig. 104).

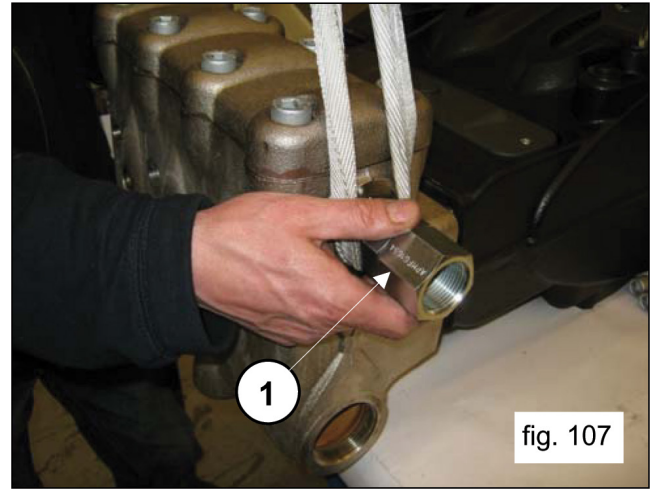
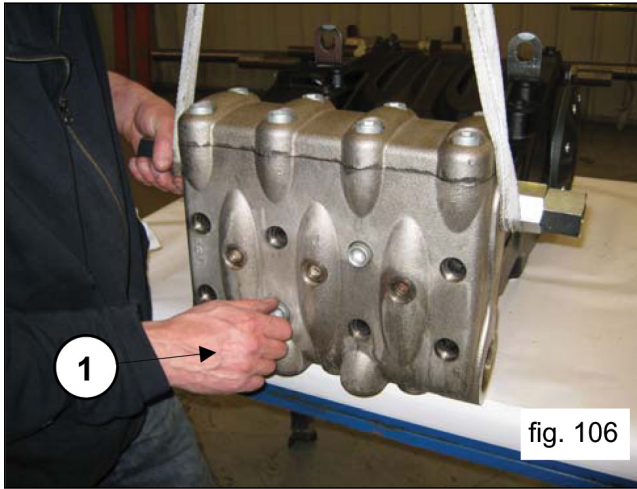


Remove the suction and outlet valve units, unscrewing an M10 screw in such a way to press on the inner guide and remove the valve guide from the valve housing (1, fig. 105).



Complete disassembly removing the 1/4" NPT plugs on the front of the head.

It is now possible to remove the head from the pump casing, unscrewing the 8 M16 x 180 screws (1, fig. 106). During assembly of the head, pay special attention not to hit the plungers (1, fig. 107).



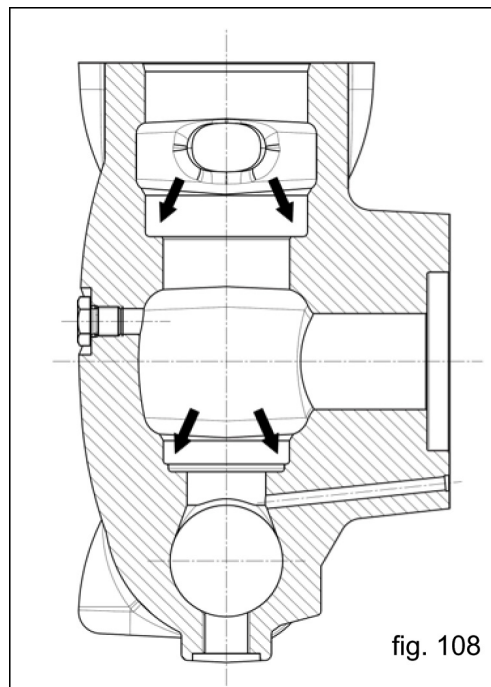
2.2.2 Assembling the MW32A, MWS36A, MWS40A - Valve Units



Pay particular attention to the conditions of the various components and replace if necessary. At every valve inspection, replace all O-rings both in the valve unit and in the valve plugs.



Before repositioning the valve unit, thoroughly clean and dry the relative housings on the head indicated by the arrows (1, fig. 108)



Proceed with reassembly following the reverse order indicated in 2.2.1.

Assemble the suction and outlet valve units (fig. 109 and fig. 110), taking care not to invert the previously disassembled springs.

To facilitate insertion of the valve guide in its housing, you can use a pipe resting on the horizontal guide planes (fig. 111) and use an extractor hammer acting on the whole circumference.

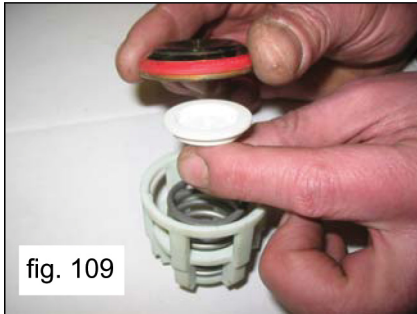


fig. 109

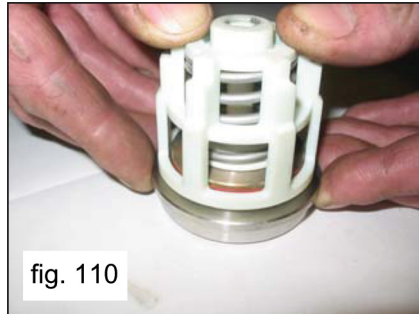


fig. 110



fig. 111



Proceed with insertion of the valve units (suction and outlet) in the head, taking care to follow the correct insertion sequence of O-rings and anti-extrusion rings.

The proper sequence of valve unit assembly on the head is as follows:
Insert the anti-extrusion ring, exploded position 5 from the Owner's Manual (1, fig. 112).

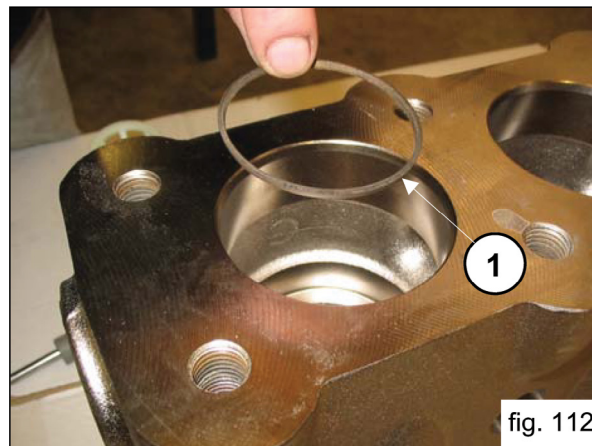


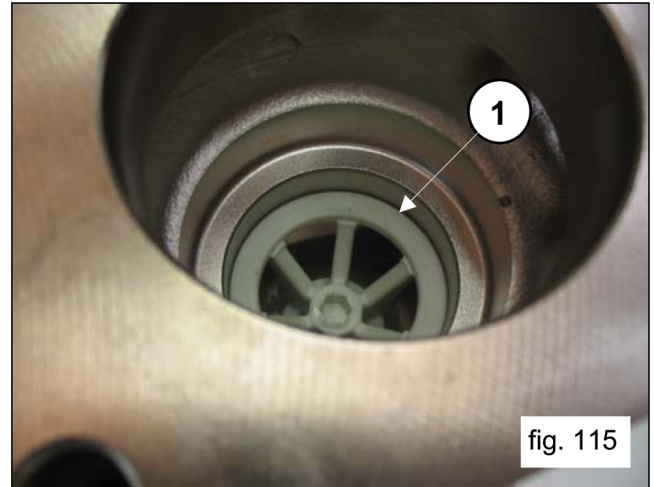
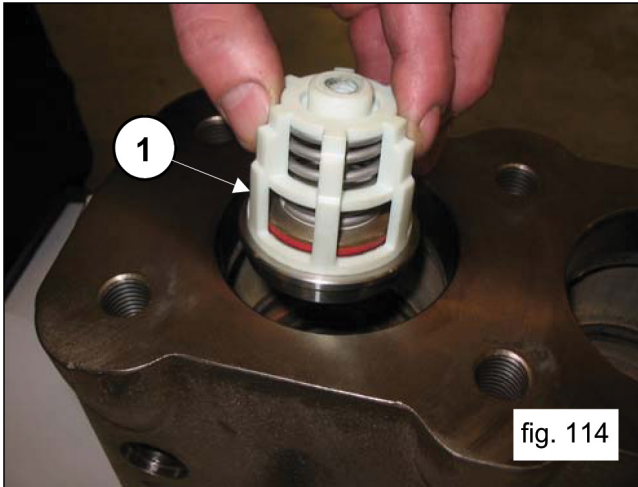
fig. 112

Insert the O-ring, exploded position 6 from the Owner's Manual (1, fig. 113).

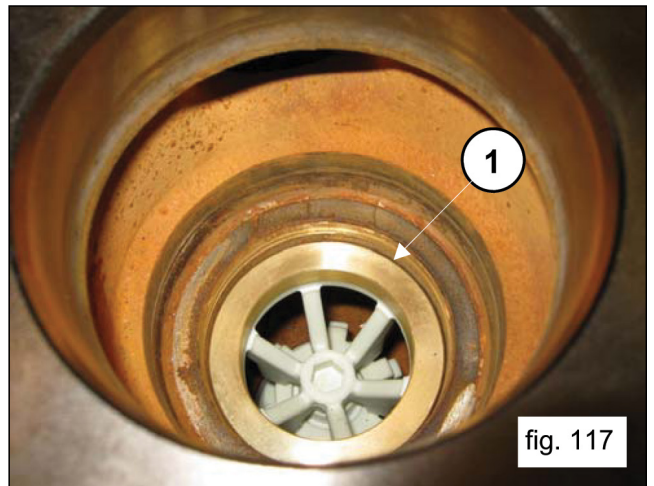
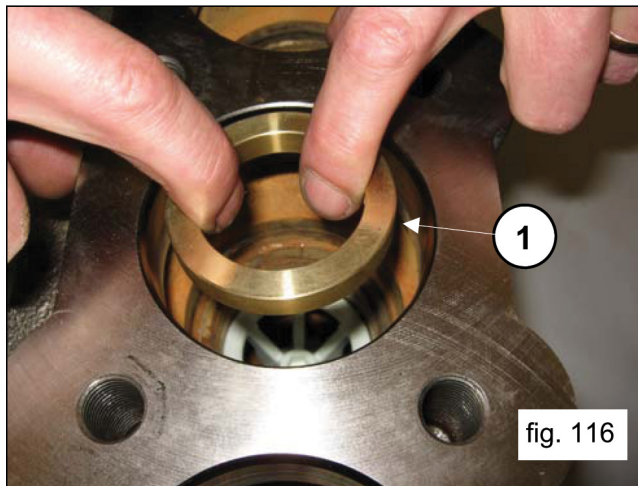


fig. 113

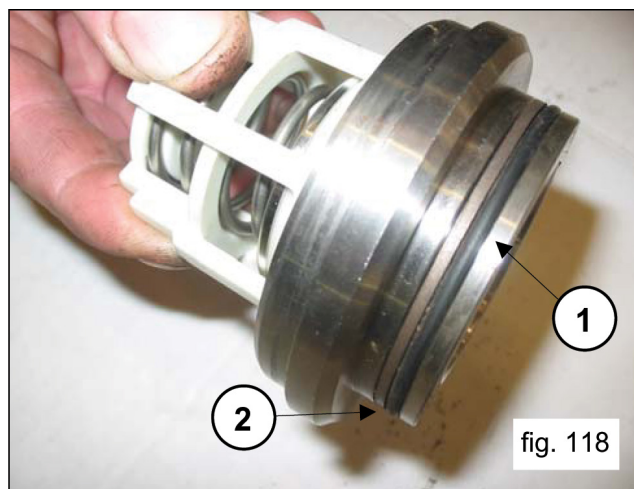
Ensure that the O-ring and anti-extrusion ring are perfectly placed in their housings. Insert the suction valve unit (1, fig. 114) and then the spacer (1, fig. 115). The complete valve unit must be fully inserted into the bottom and should look like the image in fig. 115.



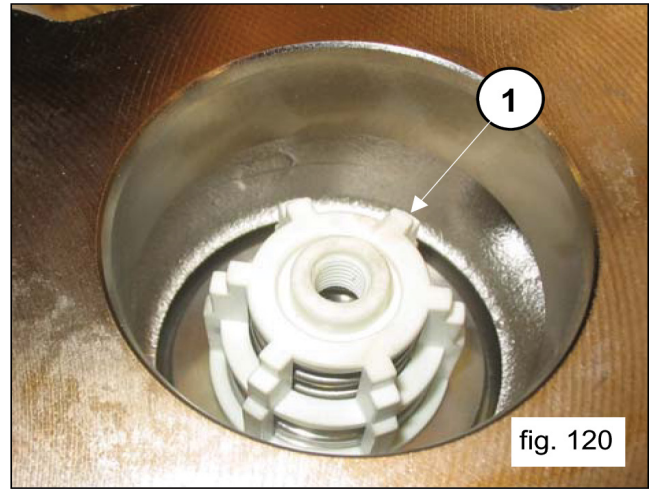
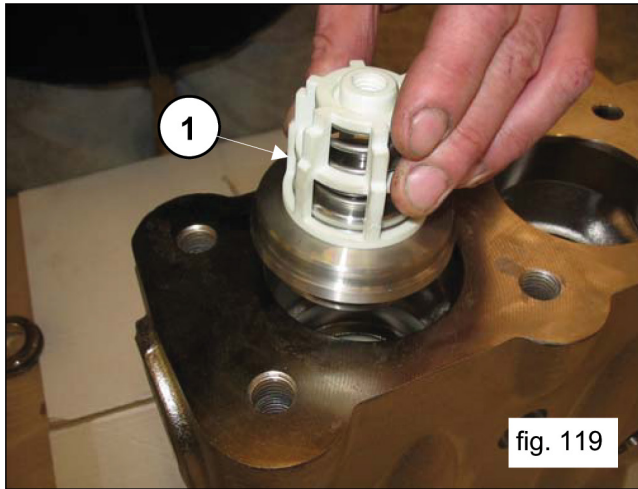
Insert the valve housing spacer ring (1, fig. 116), resting on the spacer (1, fig. 117).



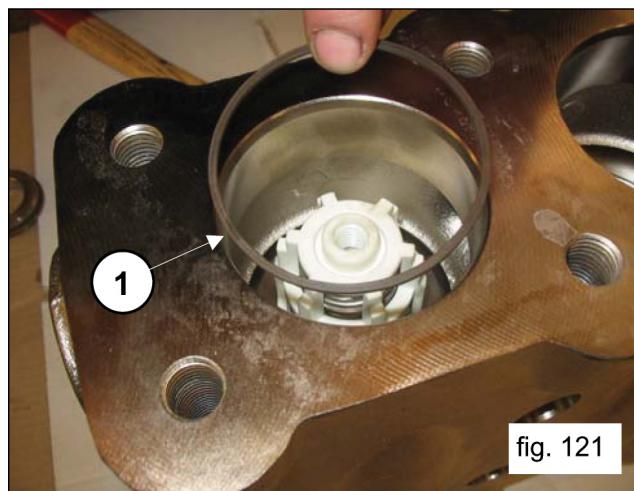
Assemble the O-ring, exploded position 6 from the Owner's manual (1, fig. 118) and the anti-extrusion ring, (2, fig. 118) on the outlet valve housing.



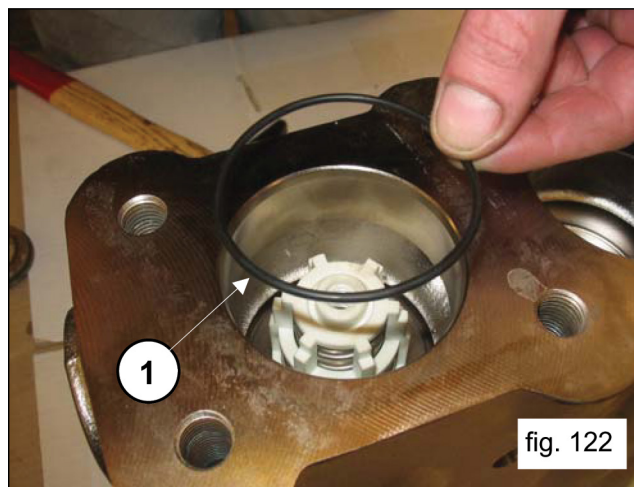
Insert the outlet valve unit (1, fig. 119). The valve unit must be fully inserted into the bottom and should look like the image in 1, fig. 120.



Insert the anti-extrusion ring, exploded view position 18 from the Owner's Manual (1, fig. 121).

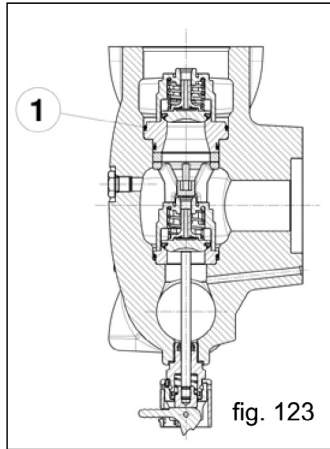


Insert the O-ring, exploded view position 19 from the Owner's Manual (1, fig. 122).

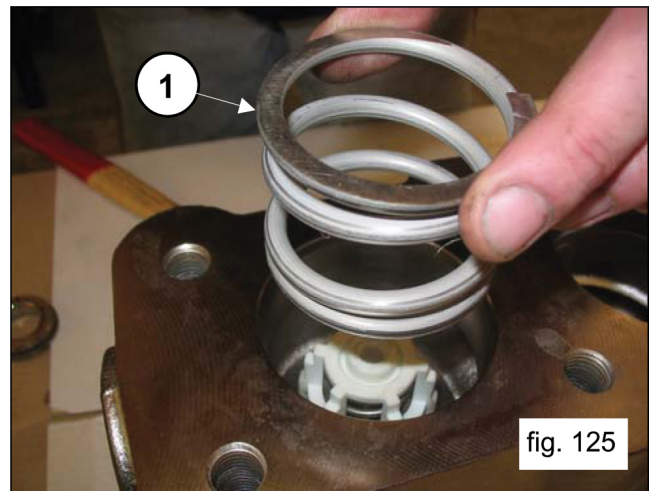
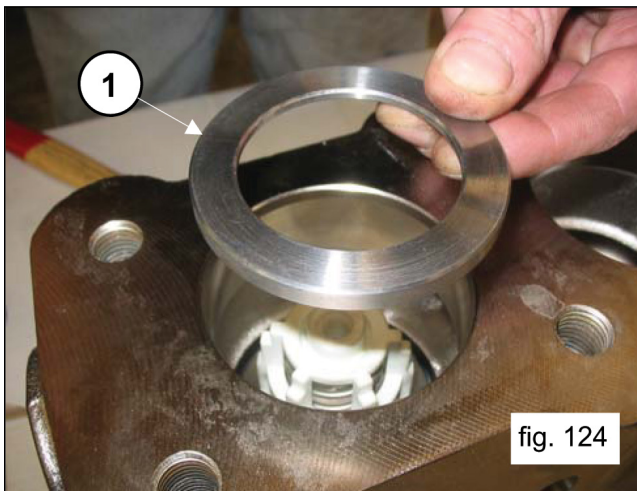




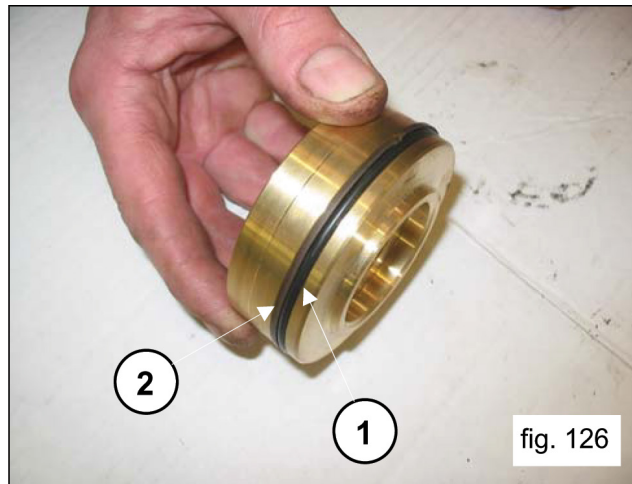
Pay special attention to O-ring insertion in 1, fig. 123. Use special tool #F27516000 to prevent the O-ring from damage during insertion.



Insert the valve housing ring (1, fig. 124) and the spring (1, fig. 125).

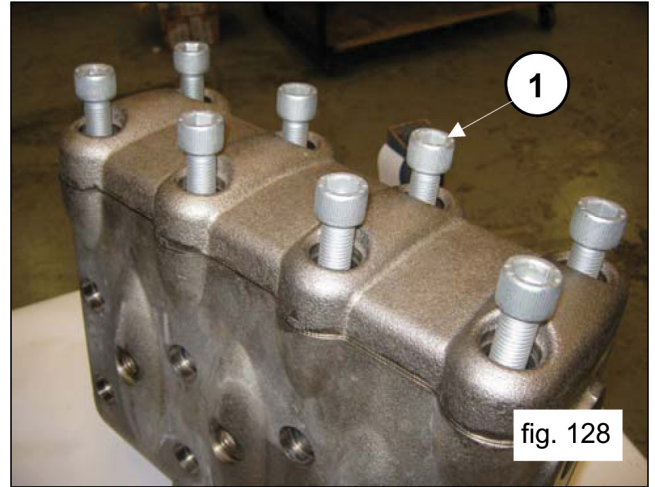
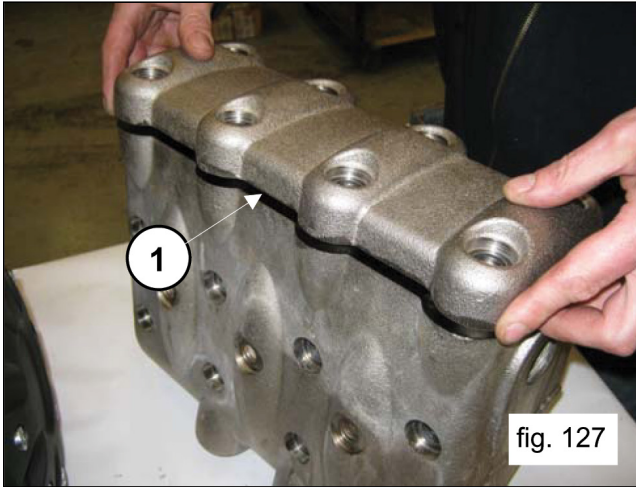


Assemble the O-ring, exploded view position 19 from the Owner's Manual (1, fig. 126) and the anti-extrusion ring, exploded view position 23 (2, fig. 126) on the outlet valve plug.

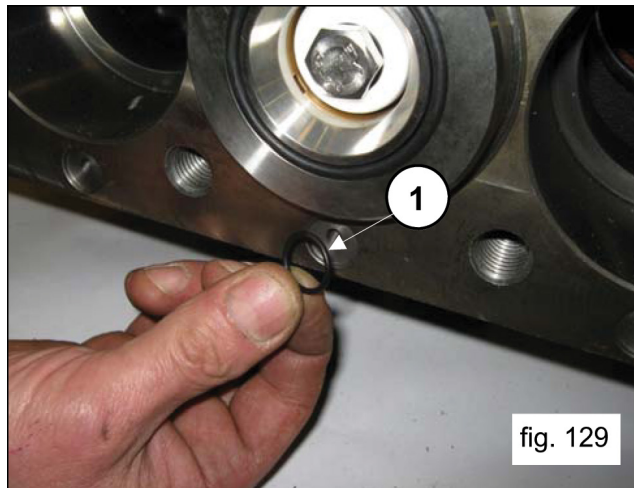


Insert the valve plug housing complete with O-ring and anti-extrusion rings.

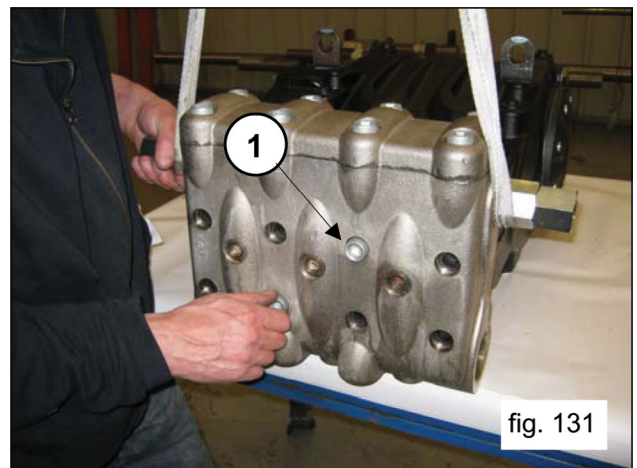
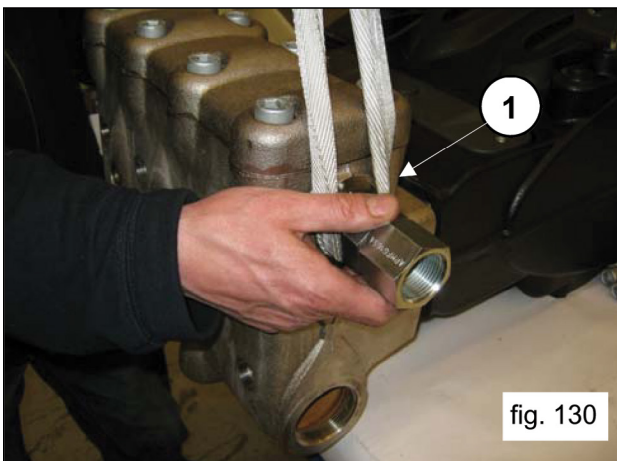
After having completed assembly of the valve units and the valve plug, apply the valve cover (1, fig. 127) and screw in the 8 M16 x 55 screws (1, fig. 128).



Apply 6 front O-rings on the pump casing (1, fig. 129).



Assemble the pump casing head (1, fig. 130) taking care not to hit the plungers and screw in the 8 M16 x 180 screws (1, fig. 131).



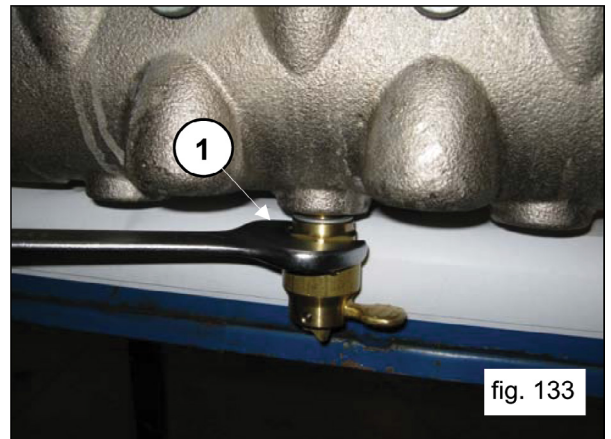
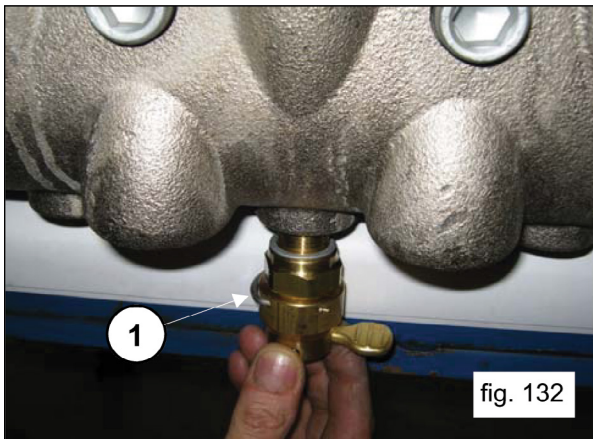
Proceed with calibration of the M16 x 180 screws with a torque wrench as indicated in paragraph 3 “Screw Tightening Calibration”.



Tighten the 8 M16 x 180 screws starting cross-wise from the 4 inner screws, to then continue with the 4 outer screws, always tightening cross-wise.

Calibrate the M16 x 55 cover screws with a torque wrench as indicated in paragraph 3, “Screw Tightening Calibration”.

Apply the valve opening devices (1, fig. 132) and screw them in with the use of a 30 mm spanner (1, fig. 133).

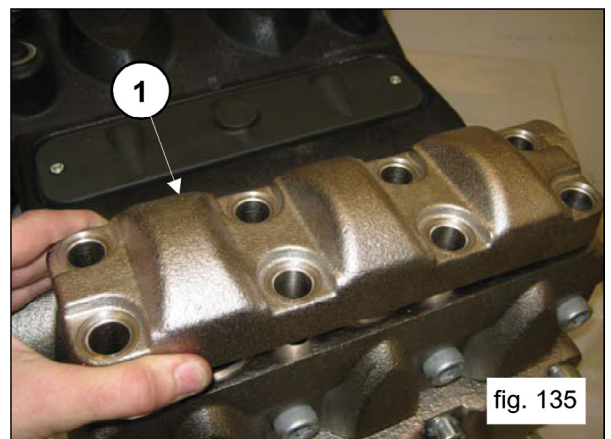
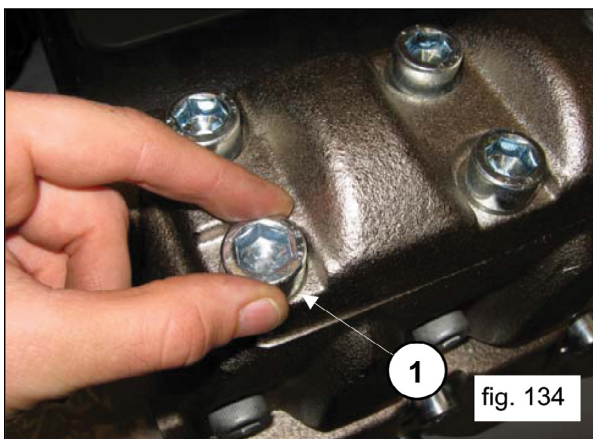


Apply the 1/4” NPT plugs on the front of the head with relative O-rings. Proceed with calibration of the 1” plugs with a torque wrench as indicated in paragraph 3 “Screw Tightening Calibration”.

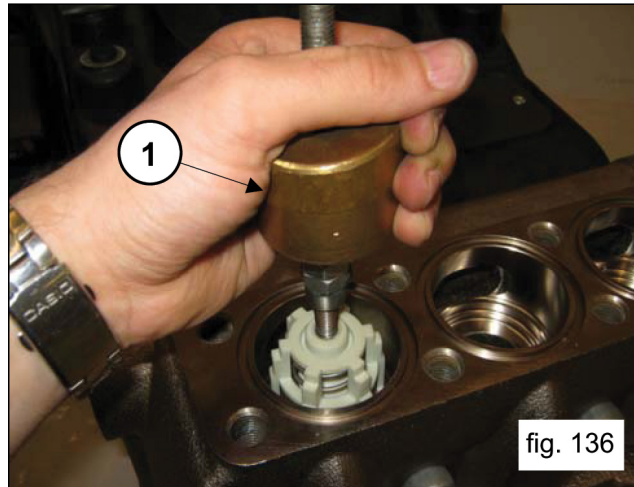
2.2.3 Dismantling the MWS45A, MWS50A and MWS55A Head-Valve Units

The head requires preventive maintenance as indicated in the Owner’s Manual. Operations are limited to inspection or replacement of valves, if necessary. Proceed as follows to extract valve groups:

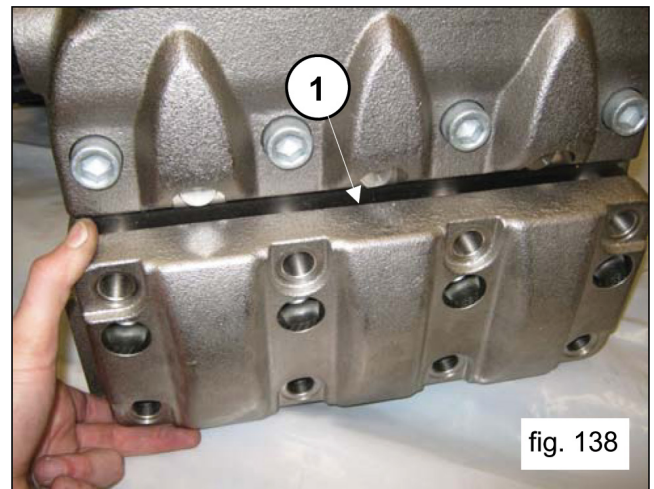
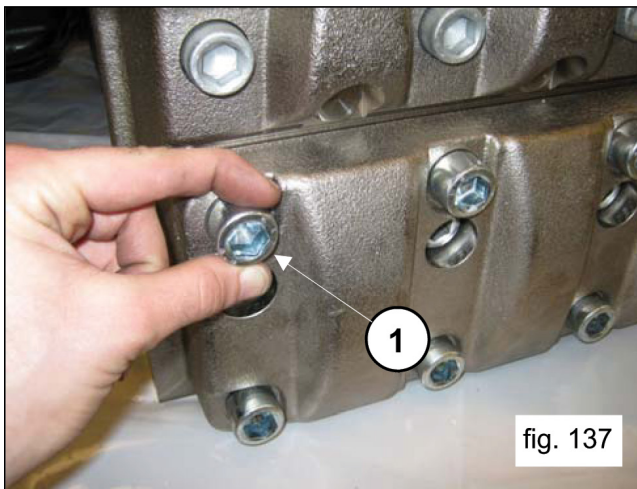
Unscrew the 8 M16 x 45 screws of the outlet valve cover (1, fig. 134) and remove the cover (1, fig. 135).



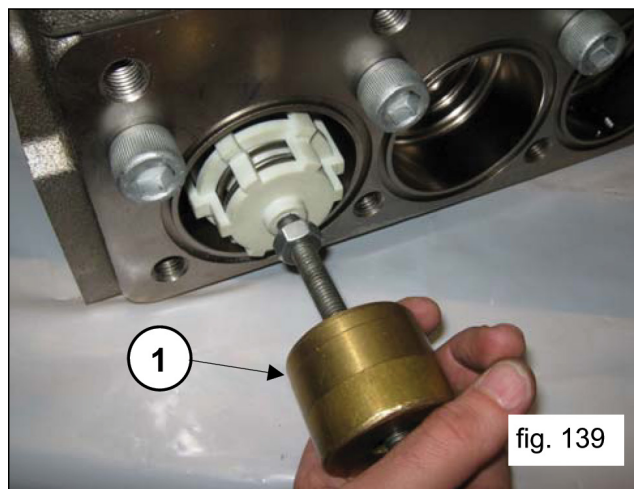
Extract the outlet valve unit with the use of an extractor hammer (#F27516400) to be applied on the M10 hole of the valve guide (1, fig. 136).



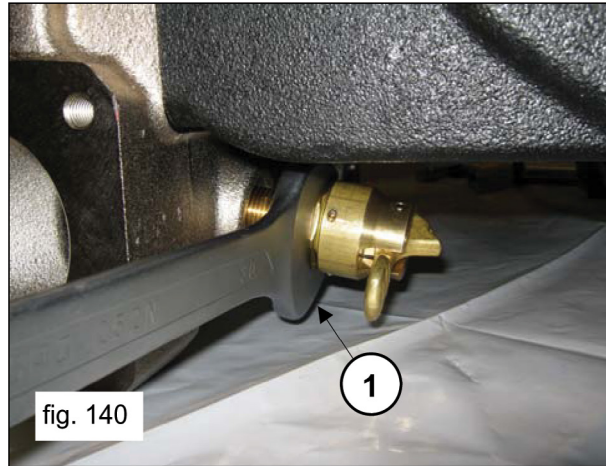
Unscrew the 8 M16 x 45 screws of the suction valve cover (1, fig. 137) and remove the cover (1, fig. 138).



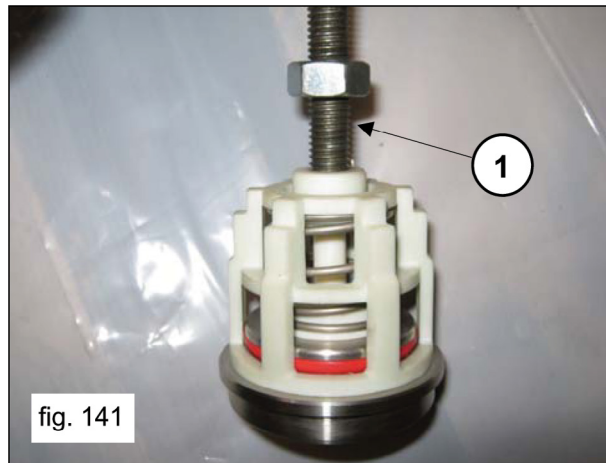
Extract the suction valve unit with the use of an extractor hammer (#F27516400) to be applied on the M10 hole of the valve guide (1, fig. 139).



Unscrew the valve opening device by means of a 30 mm spanner (1, fig. 140).

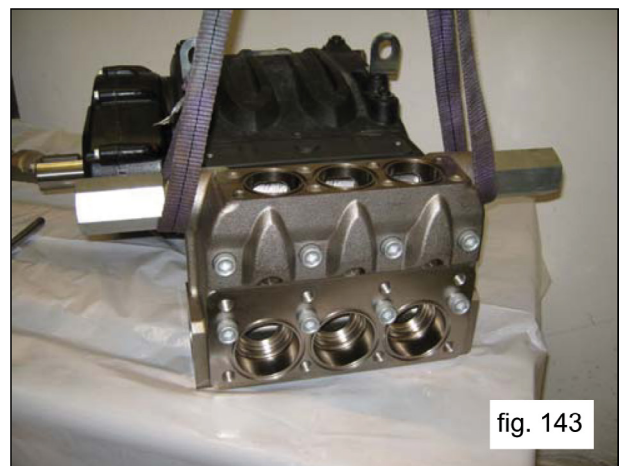
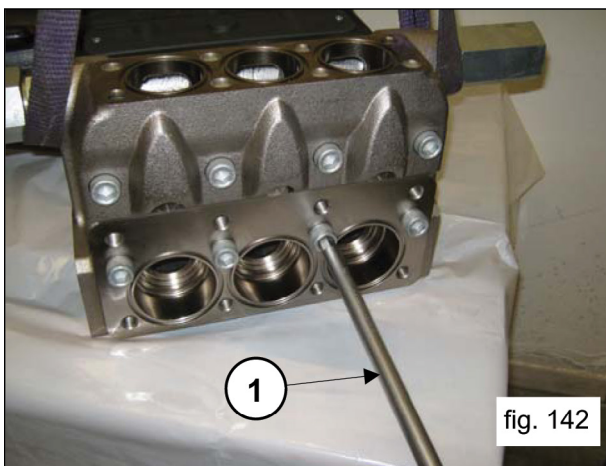


Remove the suction and outlet valve units, unscrewing an M10 screw in such a way to press on the inner guide and remove the valve guide from the valve housing. (1, fig. 141).



Complete disassembly removing the 1/4" plugs on the front of the head and the 1/2" plugs on the lower part of the head.

It is now possible to remove the head from the pump casing, unscrewing the 8 M16 x 150 screws (1, fig. 142). During assembly of the head, pay special attention not to hit the plungers (fig. 143).



2.2.4 Assembling the MWS45A, MWS50A and MWS55A Head-Valve Units



Pay particular attention to the conditions of the various components and replace if necessary. At every valve inspection, replace all O-rings both in the valve unit and in the valve plugs.



Before repositioning the valve unit, thoroughly clean and dry the relative housings on head indicated by the arrows (1, fig. 144).

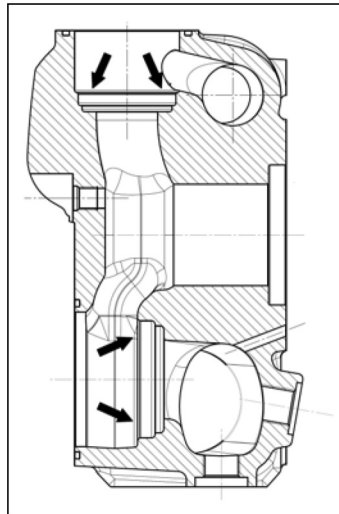


fig. 144

Proceed with reassembly following the reverse order indicated in point 2.1.3.

Assemble the suction and outlet valve units (fig. 145 and fig. 146).

To facilitate insertion of the valve guide in its housing, you can use a pipe resting on the horizontal guide planes (fig. 147) and use an extractor hammer acting on the whole circumference.



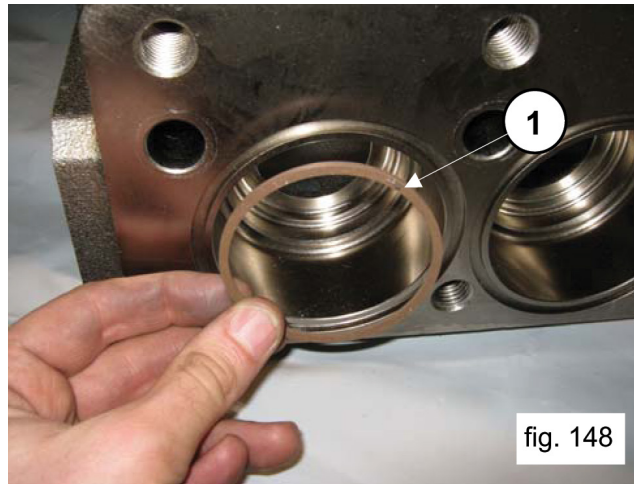
fig. 147



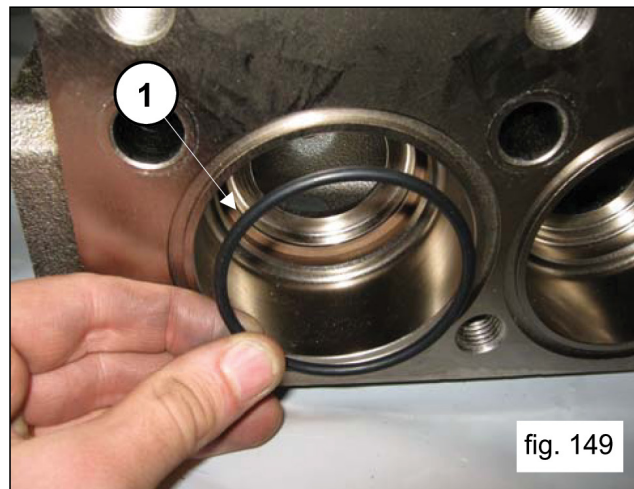
Proceed with insertion of the valve units (suction and outlet) in the head, taking care to follow the correct insertion sequence of O-rings and anti-extrusion rings.

The proper sequence of valve unit assembly on the head is as follows:

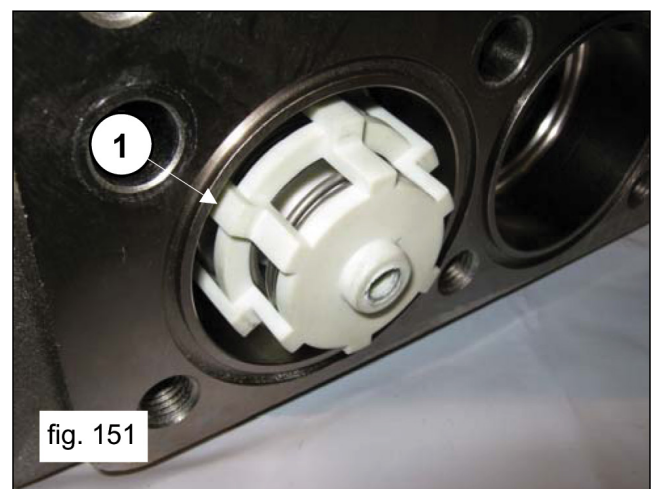
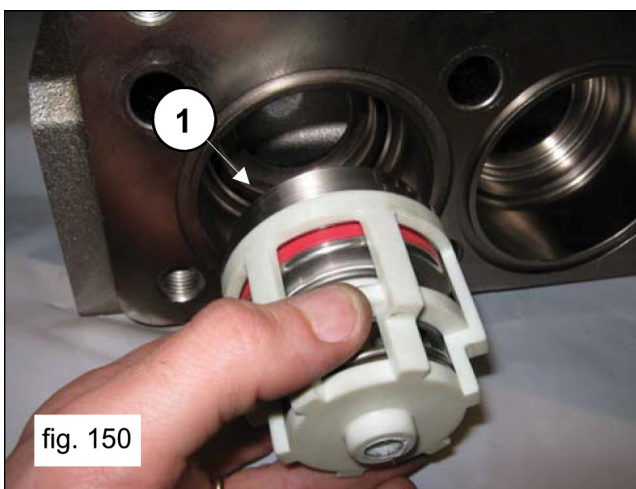
During suction, insert the anti-extrusion ring, exploded view position 6 from the Owner's Manual, (1, fig. 148).



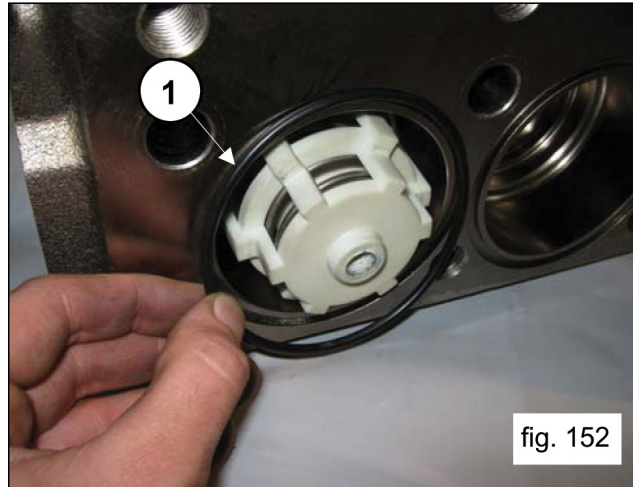
Insert the O-ring, exploded view position 7 in the Owner's Manual, (1, fig. 149).



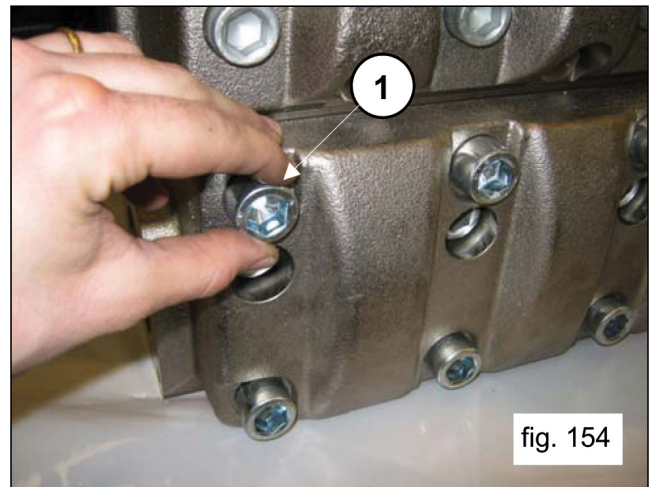
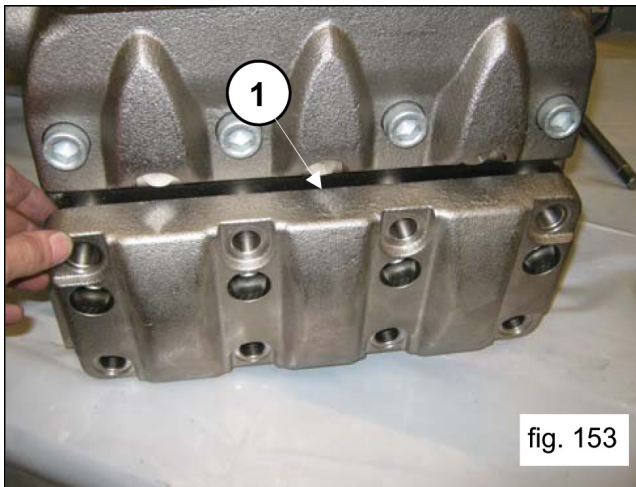
Ensure that the O-ring and anti-extrusion ring are perfectly placed in their housings. Insert the suction valve unit (1, fig. 150). The complete valve unit must be fully inserted into the bottom and should look like the image in fig. 151.



Insert the front O-ring in the suction valve (1, fig. 152).

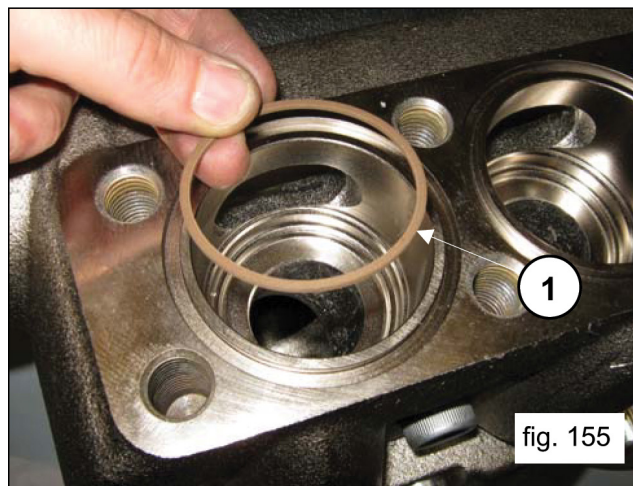


After having completed assembly of the suction valve units, apply the suction valve cover (1, fig. 153) and screw in the 8 M16 x 45 screws (1, fig. 154).

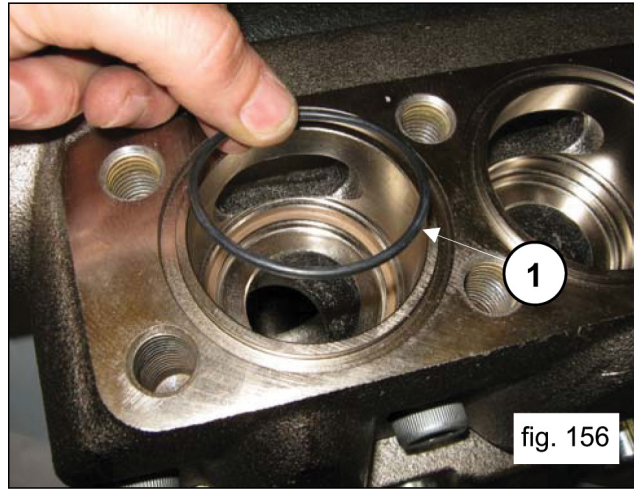


Proceed with outlet valve assembly:

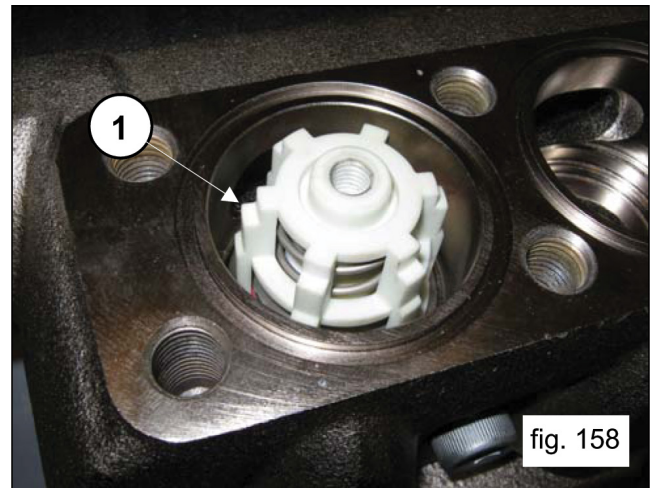
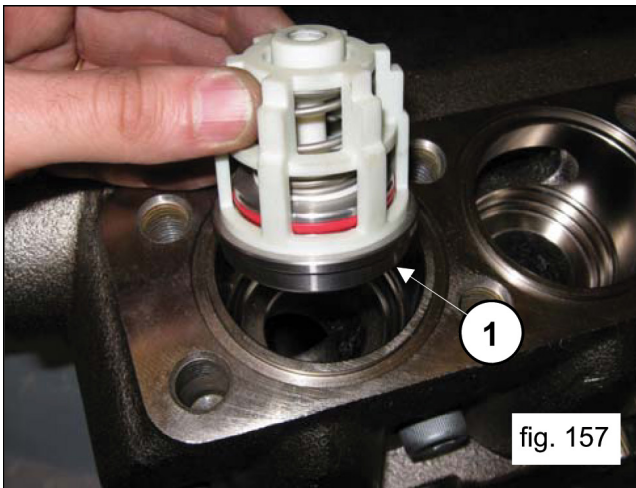
Insert the anti-extrusion ring, exploded view position 23 from the Owner's Manual, (1, fig. 155).



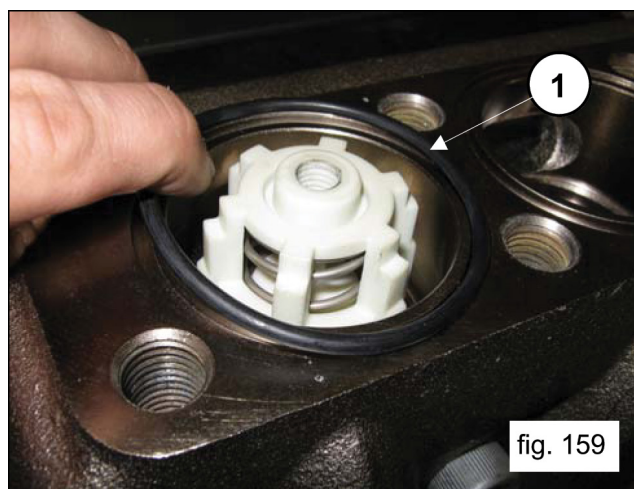
Insert the O-ring, exploded view position 24 from the Owner's Manual, (1, fig. 156).



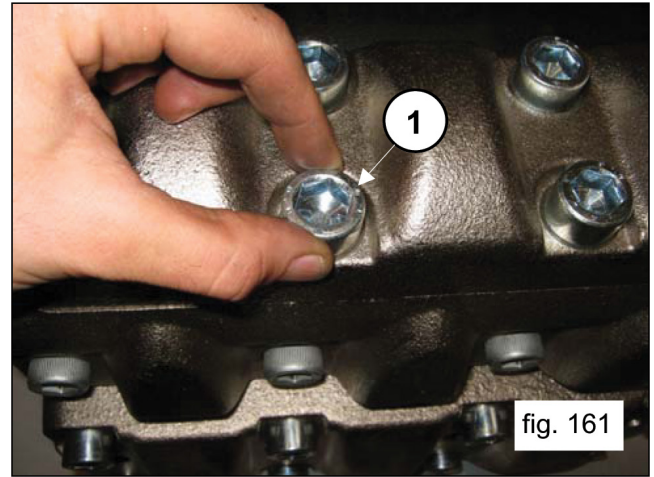
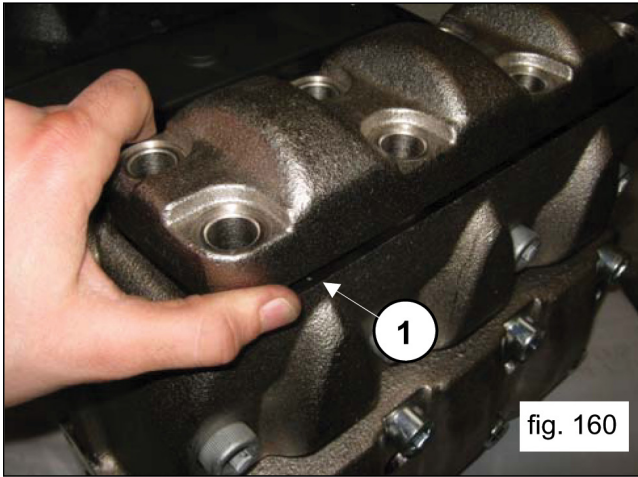
Ensure that the O-ring and anti-extrusion ring are perfectly placed in their housings. Insert the outlet valve unit (1, fig. 157). The complete valve unit must be fully inserted into the bottom and should look like the image in fig. 158.



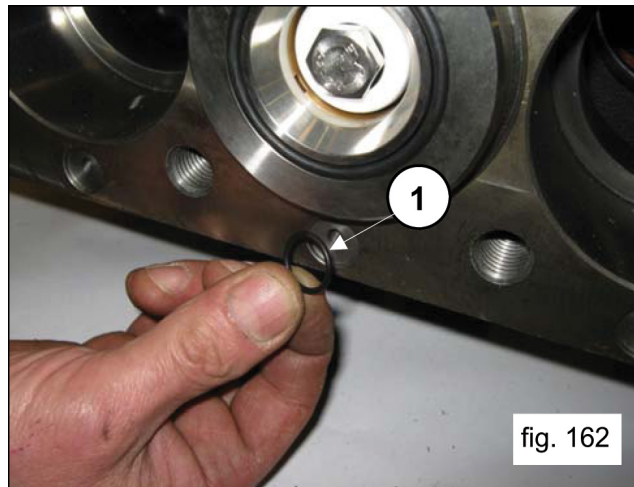
Insert the front O-ring in the outlet valve (1, fig. 159).



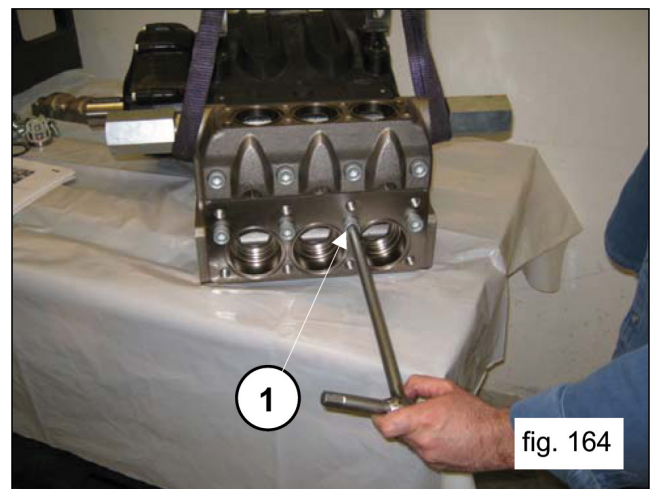
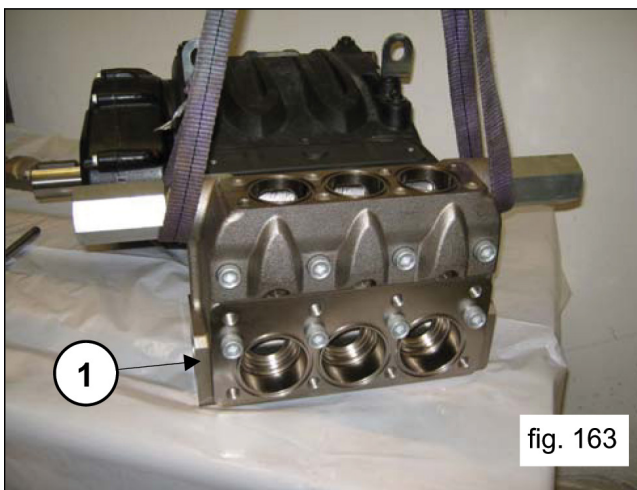
After having completed assembly of the outlet valve units, apply the outlet valve cover (1, fig. 160) and screw in the 8 M16 x 45 screws (1, fig. 161).



Apply 6 front O-rings on the pump casing (1, fig. 162).



Assembly the pump casing head (1, fig. 163) taking care not to hit the plungers and screw in the 8 M16 x 150 screws (1, fig. 164).



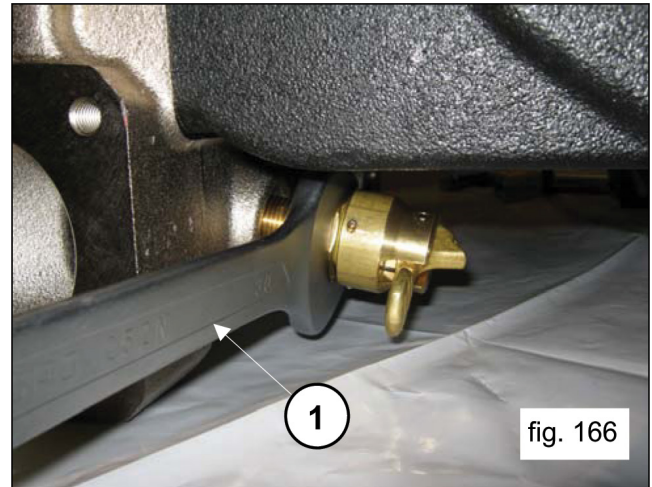
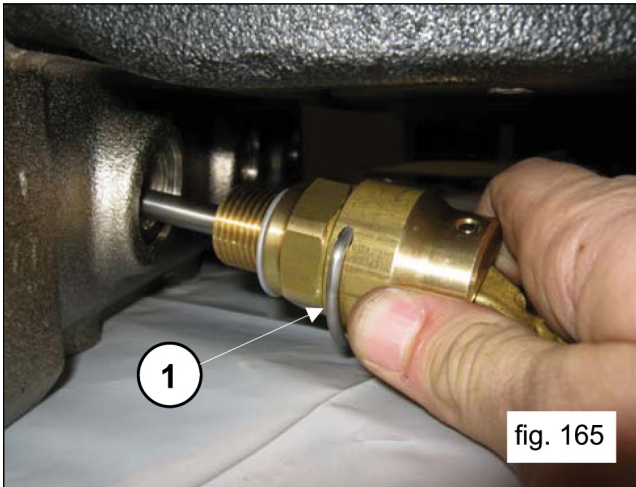
Proceed with calibration of the M16 x 150 screws with a torque wrench as indicated in paragraph 3, "Screw Tightening Calibration".



Tighten the 8 M16 x 180 screws starting cross-wise from the 4 inner screws, then continue with the 4 outer screws, always tightening cross-wise.

Calibrate the M16 x 45 suction and outlet cover screws with a torque wrench as indicated in paragraph 3 “screw Tightening Calibration”.

Apply the valve opening devices (1, fig. 165) and screw them in with the use of a 30 mm spanner (1, fig. 166).



Apply the 1/2” plugs on the lower part of the head with relative washers. Proceed with calibration of the 1/2” plugs with a torque wrench as indicated in paragraph 3 “Screw Tightening Calibration”.

Apply the 1/4” plugs on the front of the head with relative O-rings. Proceed with calibration of the 1/4” plugs with a torque wrench as indicated in paragraph 3 “Screw Tightening Calibration”.

2.2.5 Dismantling the Plunger Unit - Supports - Seals

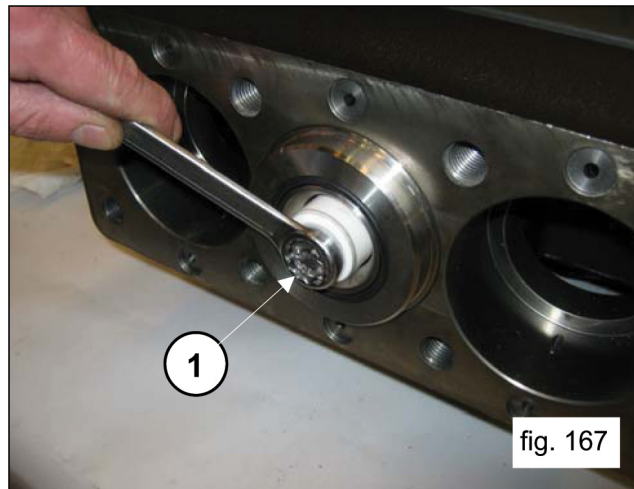
The plunger unit requires preventive checks as indicated in the preventive maintenance table in the Owner’s Manual. Maintenance is limited to visual inspection of any drainage from the hole present on the lower inspection cover. If abnormalities / variations on the outlet pressure gauge or dripping from the drainage hole circuit are detected, the seal packings will have to be checked and replaced.

To access the plunger unit, unscrew the M18 x 180 screws (for MW32A, MWS36A and MWS40A) or M16 x 150 screws (for MWS45A, MWS50A and MWS55A) and remove the head.

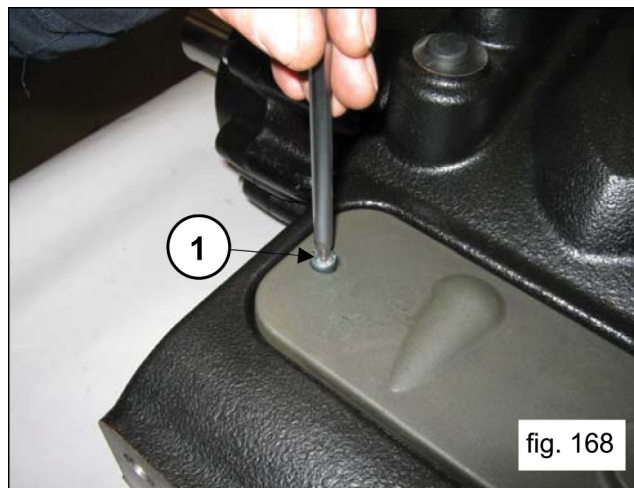


Remove the head taking care to avoid hitting the plungers.

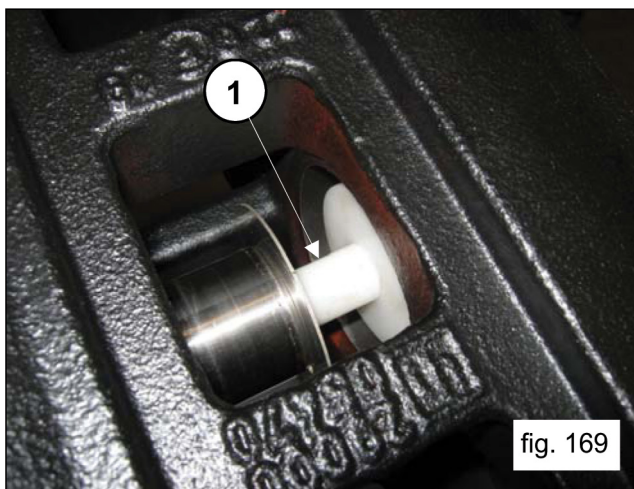
Disassemble plungers unscrewing the fixing screws (1, fig 167). Remove the plunger from the seal support and check that its surfaces do not present any scratches, signs of wear or cavitation.



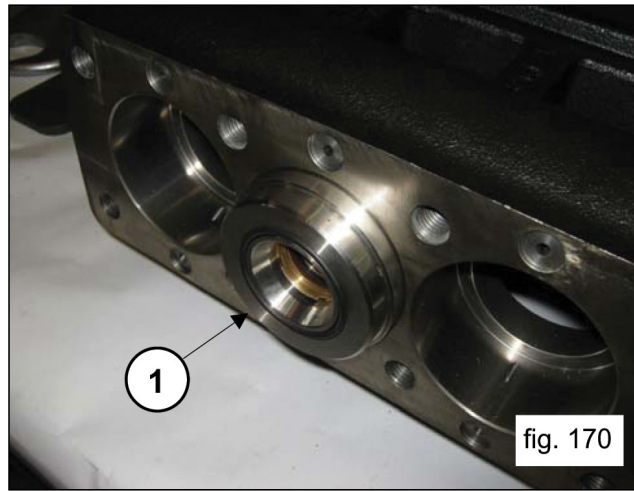
Remove the upper inspection cover, unscrewing the 2 fixing screws (1, fig. 168).



Manually turn the shaft in such a way to bring the 3 plungers to the upper dead center position. Insert the buffering tool (#F27632500) between the plunger guide and the plunger (1, fig. 169).

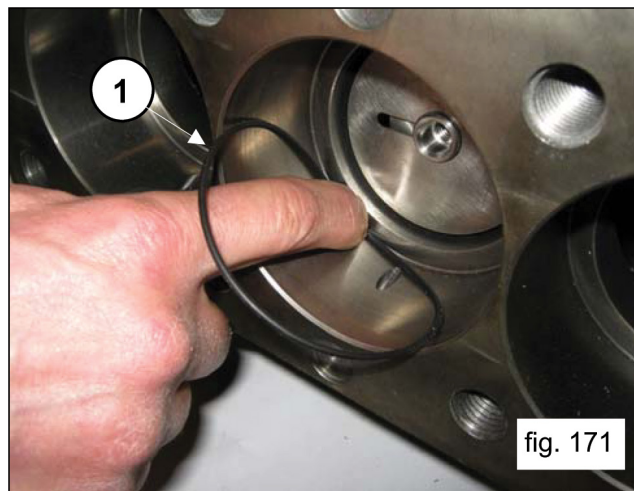


Turning the shaft, have the plunger guide move forward so that the buffer, moving ahead, can expel the seal support and the entire plunger unit (1, fig. 170).

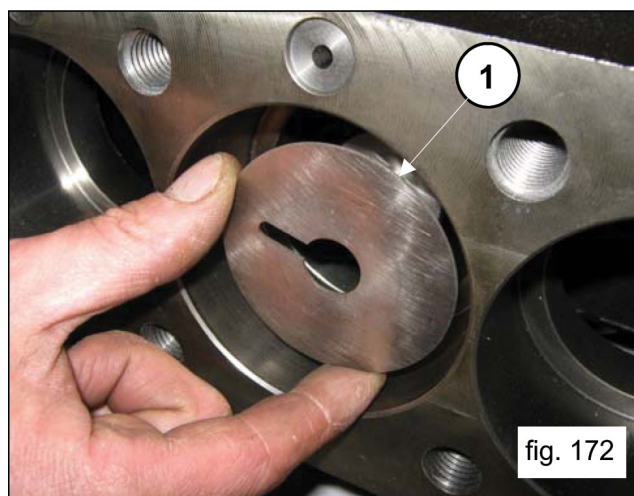


Extract the seal support unit and the buffering tool.

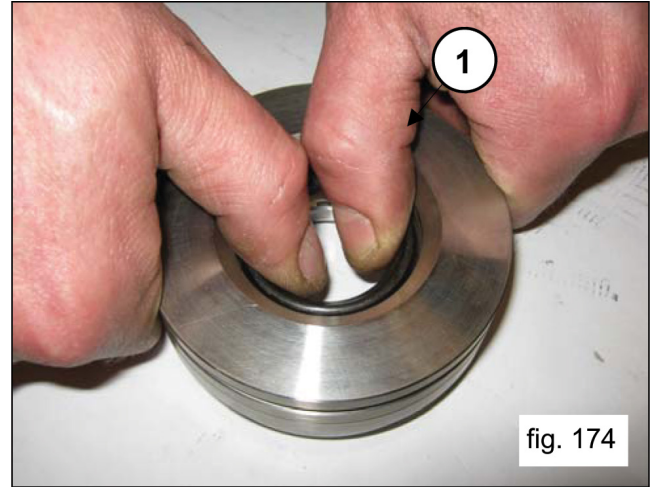
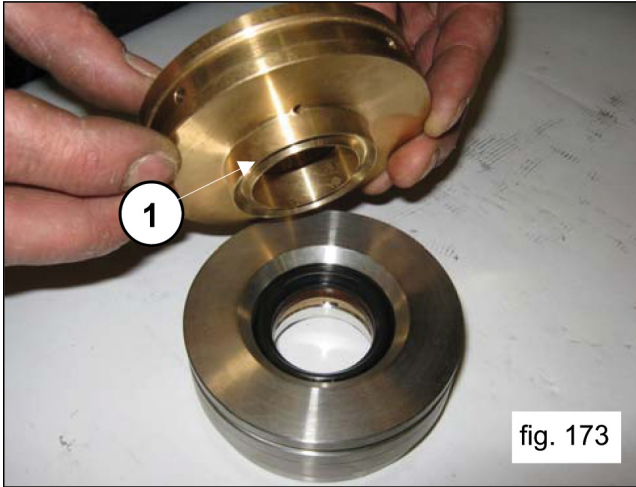
Remove the seal support bottom O-ring should it remain inside the pump casing (1, fig. 171).



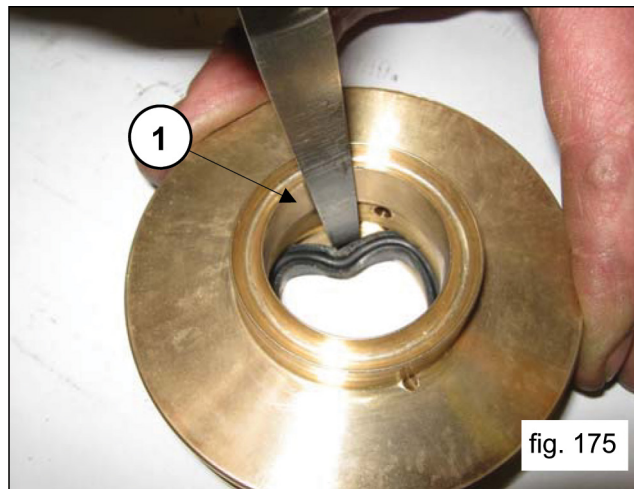
Remove the spray rings from the plunger guides (1, fig. 172).



Separate the seal support from the liner (1, fig. 173) to access the pressure seals (1, fig. 174).



To remove the low pressure seal, use a thickness gauge or another tool which will not damage the seal support housing (1, fig. 175).



2.2.6 Re-assembling the Plunger Unit - Support - Seals

Proceed with re-assembly following the reverse order indicated in point 2.2.5.

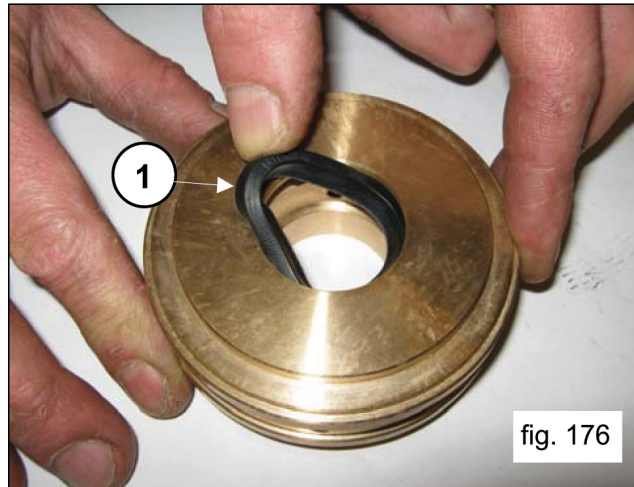


Replace the pressure seals moistening the lips with silicone grease (without spreading it), taking extra care not to damage them during liner insertion.

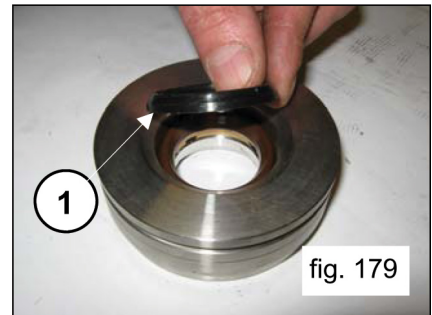
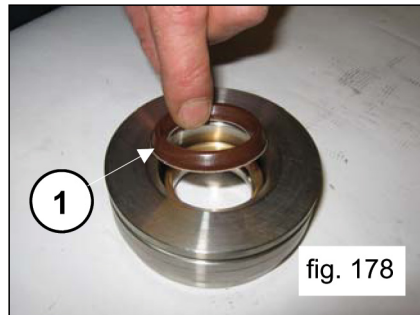
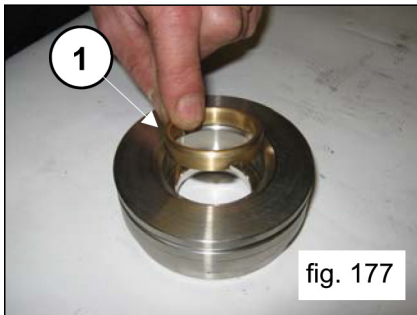


The O-rings and the low pressure seals must be replaced at each disassembly.

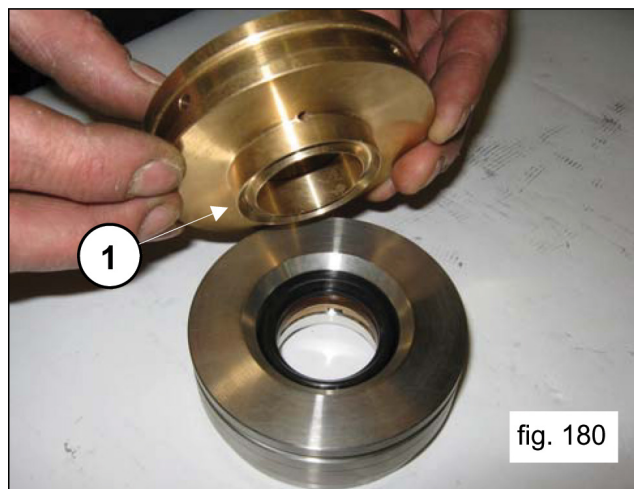
Insert the low pressure seal in the seal support (1, fig. 176) paying attention to the mounting direction which requires that the sealing lip be set forward (toward the head).



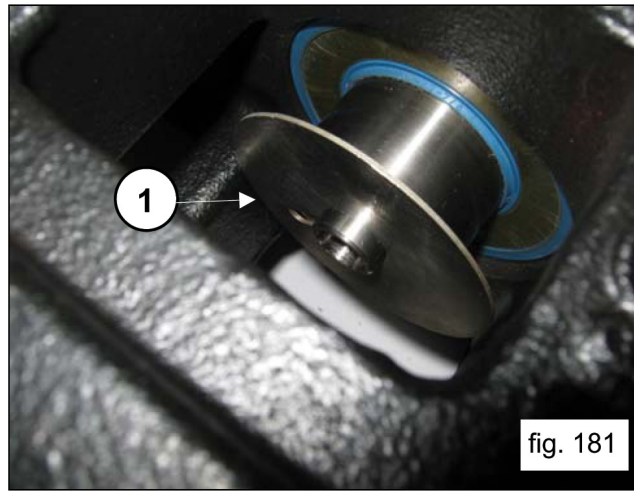
Install the head ring (1, fig. 177), the high pressure seal (1, fig 178) and the re-stop ring (1, fig. 179).



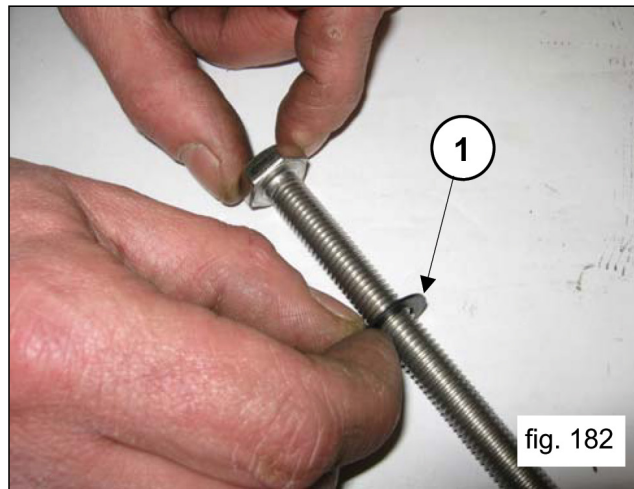
Join the seals supports to the liner (1, fig. 180).



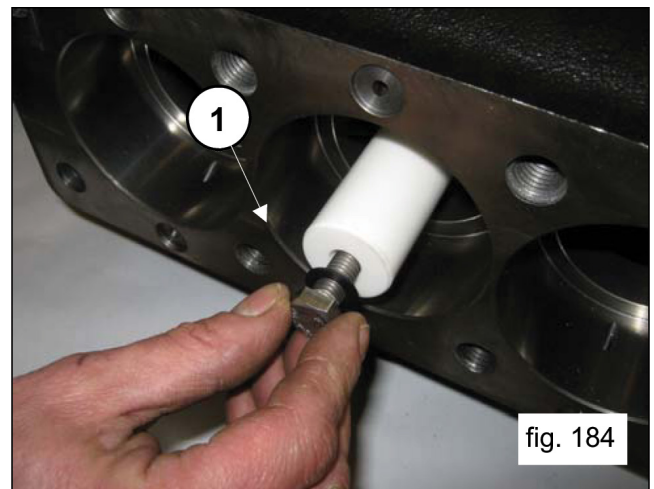
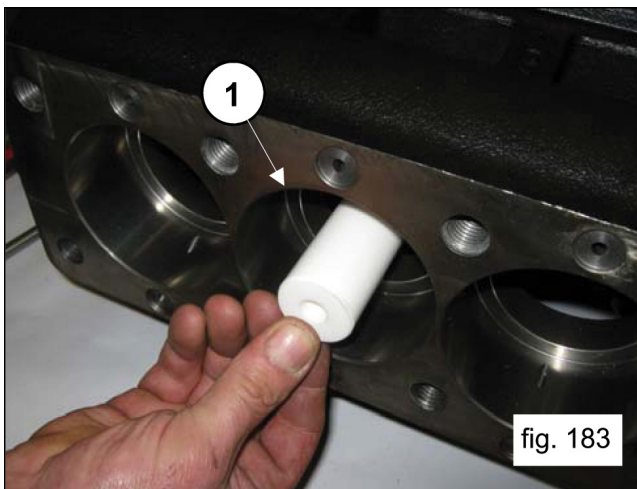
Position the spray hood in the plunger guide housing (1, fig. 181).



Insert the Ø10 x 18 x 0.9 washer in the plunger fixing screw (1, fig. 182).

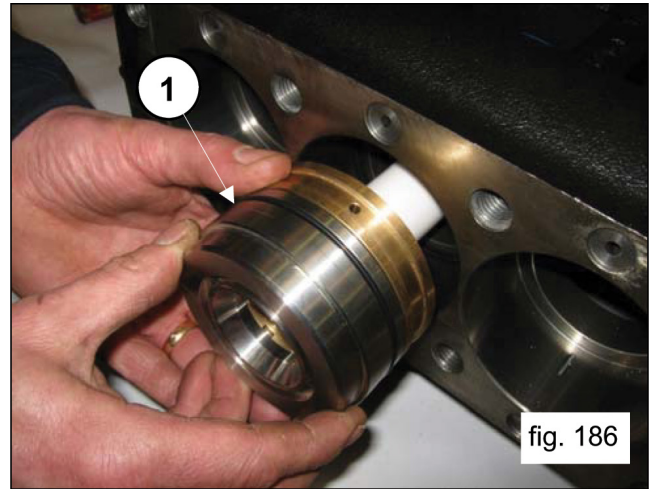
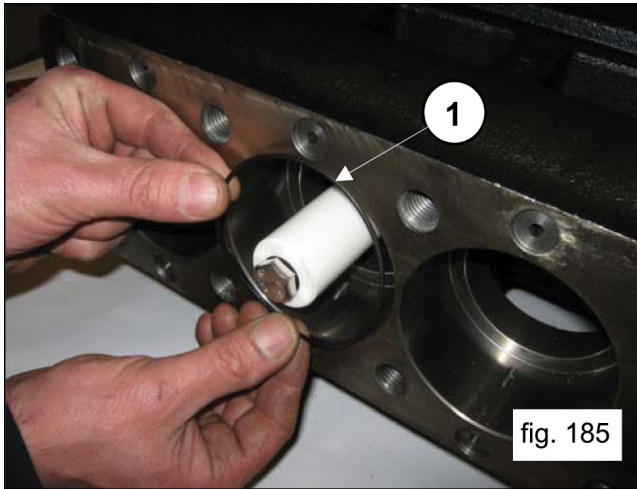


Install the plungers on their respective guides (1, fig. 183) and fasten them as per 1, fig. 184.

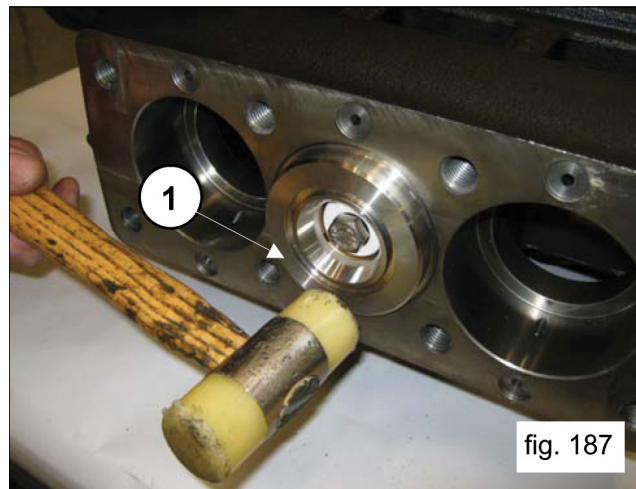


Calibrate the screws with a torque wrench as indicated in paragraph 3 "Screw Tightening Calibration".

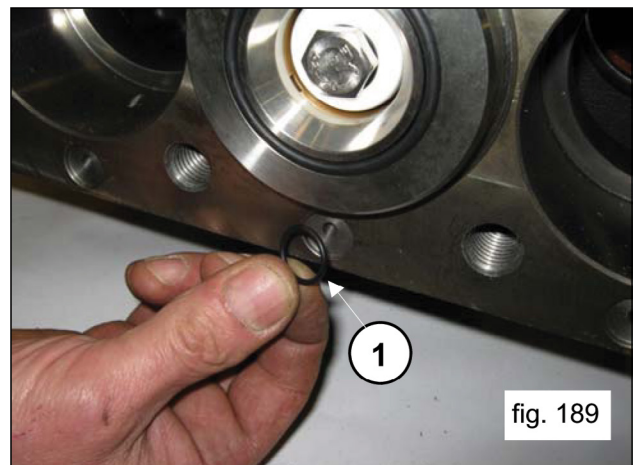
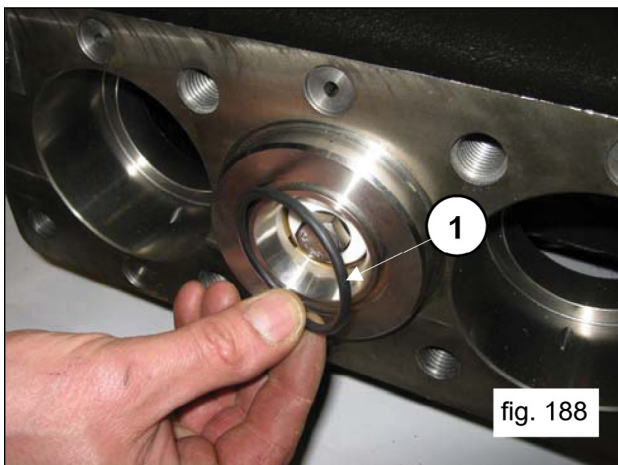
Insert the O-ring inside the pump casing (1, fig. 185) and then the previously-assembled liner-seal support block (complete with the same O-ring) to end stroke (1, fig. 186).



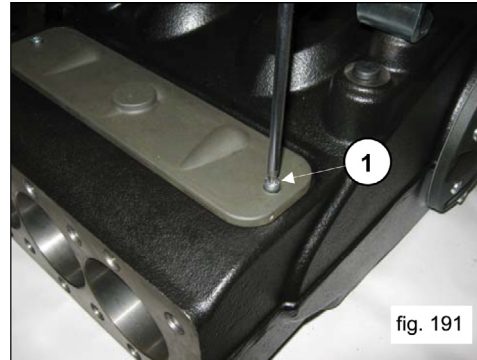
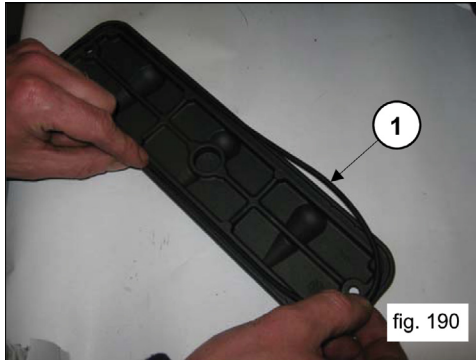
Ensure that the liner-support block is positioned correctly down to the bottom of the housing (1, fig. 187).



Install the front O-ring in the liner (1, fig. 188) and the recirculation hole O-ring (1, fig. 189).



Insert the O-ring on the inspection covers (1, fig. 190) and assemble the covers with the use of 2+2 M6 x 14 screws (1, fig. 191).



Calibrate the screws with a torque wrench as indicated in paragraph 3, “Screw Tightening Calibration”.

3. SCREW CALIBRATION

Screws are to be fastened exclusively using a torque wrench.

Description	Exploded View Position (From Owner’s Manual)	Fastening Ft. Lbs.	Fastening Nm
Crankcase cover screws M10 x 30	89 (MW32A, MWS36A, MWS40A)	33.2	45
Crankcase cover screws M10 x 30	91 (MWS45A, MWS50A, MWS55A)	33.1	45
Casing Plug, 1/2” x 13	91 (MW32A, MWS36A, MWS40A)	29.5	40
Casing Plug, 1/2” x 13	93 (MWS45A, MWS50A, MWS55A)	29.5	40
Lifting Bracket M16 x 30 Screw	51 (MW32A, MWS36A, MWS40A)	147.5	200
Lifting Bracket M16 x 30 Screw	53 (MWS45A, MWS50A, MWS55A)	147.5	200
Reducer cover screw M10x40	81 (MW32A, MWS36A, MWS40A)	33.2	45
Reducer cover screw M10x40	83 (MWS45A, MWS50A, MWS55A)	33.2	45
Ring gear stopper screw M10 x 25	76 (MW32A, MWS36A, MWS40A)	59.0	80
Ring gear stopper screw M10 x 25	78 (MWS45A, MWS50A, MWS55A)	59.0	80
Reducer case screw M10x40	81 (MW32A, MWS36A, MWS40A)	33.2	45
Reducer case screw M10x40	83 (MWS45A, MWS50A, MWS55A)	33.2	45
Upper cover screw M6x14	60 (MW32A, MWS36A, MWS40A)	7.4	10
Upper cover screw M6x14	62 (MWS45A, MWS50A, MWS55A)	7.4	10
Lower cover screw M6x14	108 (MW32A, MWS36A, MWS40A)	7.4	10
Lower cover screw M6x14	111 (MWS45A, MWS50A, MWS55A)	7.4	10
Bearing cover screw m10x30	89 (MW32A, MWS36A, MWS40A)	33.2	45
Bearing cover screw m10x30	9 (MWS45A, MWS50A, MWS55A)	33.2	45
Connecting rod screw M10x1.5x80	53 (MW32A, MWS36A, MWS40A)	47.9*	65*
Connecting rod screw M10x1.5x80	55 (MWS45A, MWS50A, MWS55A)	47.9*	65*
Plunger guide screw M10x20	47 (MW32A, MWS36A, MWS40A)	7.4	10
Plunger guide screw M10x20	49 (MWS45A, MWS50A, MWS55A)	7.4	10
Plunger guide screw M10x140	28 (MW32A, MWS36A, MWS40A)	29.5	40
Plunger guide screw M10x140	18 (MWS45A, MWS50A, MWS55A)	29.5	40
Valve Cover Screw M16 x 55 (MW32A, MWS36A, MWS40A)	24	245.6	333
Valve Outlet Cover Screw M16 x 45 (MWS45A, MWS50A, MWS55A)	19	245.6	333
Valve Inlet Cover Screw M18 x 45 (MWS45A, MWS50A, MWS55A)	120	361.4	490
Head plug 1/4” (MWS45A, MWS50A, MWS55A)	4	29.5	40
Head plug 1/4”x13	100 (MW32A, MWS36A, MWS40A)	29.5	40
Head plug 1/4”x13	21 (MWS45A, MWS50A, MWS55A)	29.5	40
Head screw M16x180	26	245.6**	333**
Head screw M16x150	43	245.6**	333**
Valve opening device	2	29.5	40

* Achieve coupling torque tightening screws at the same time.

** Tightening sequence always cross-wise starting from the 4 internal screws then the 4 external screws (see fig. 131).

4. REPAIR TOOLS

Pump maintenance may be carried out using simple tools for assembling and disassembling components. The following tools are available:

KIT		For Assembly:	
		• Shaft (con-rod interlocking)	F27566200
		• Bearing on crankshaft	F27604700
		• Pinion bearing on reduction gear box	F27604900
		• Crankshaft bearing on the reduction gear box.	F27605000
		• Crankshaft bearing on the bearing cover.	F27605000
B		• Oil seal insertion tool, MW/S	F27605300
B		• Oil seal insertion cone, MW/S	F27634400
		• Bearing on pinion	F27604800
		• Pinion seal ring.	F27634900 plus F27635000
D		• Outlet valve housing O-ring MW32A, MWS36A, MWS40A	F27516000
KIT		For Disassembly:	
B		• Oil seal extraction tool	F27644300
B		• Bolt for oil seal extraction tool	99366900
		• Shaft (con-rod interlocking)	F27566200
D		• Outlet and suction valve units	F27516400
D		• Suction valve housing MW32A, MWS36A, MWS40A	F27516200
C		• Cylinder removal tool w/handle, MW/S series	F27632500
A		• Slide hammer, MW/S valve tool.	F26019400
A		• 8mm x 10mm adapter, MW/S slide hammer	F27513600
A		• 32mm collett for MW/S discharge seat	520339
A		• 42mm collett for MW/S inlet valve seat	520340

RECOMMENDED REPAIR KITS**FKITMWV - MWS45A, MWS50A, MWS55A Valve removal / Installation Tool Kit A**

Includes:	F26019400	Slide Hammer	Qty. 1
	F27513600	10mm Adapter	Qty. 1
	520339	32mm Collet	Qty. 1
	520340	42mm Collet	Qty. 1
	520426	Valve Cage Adapter	Qty. 1

FKITMWP - Piston Oil Seal Removal / Installation Tool Kit B

Includes:	F27605300	Insertion Tool	Qty. 1
	F27634400	Insertion Cone	Qty. 1
	F27644300	Extraction Tool	Qty. 1
	99366900	Extraction Tool Bolt	Qty. 1
	F27540200	Alignment Pins	Qty. 2

F27632500 - Cylinder Removal Tool with Handle - MW - Tool Kit C

Includes:	F27632500	Spacer with Handle	Qty. 1
-----------	-----------	--------------------	--------

530078 - Splined Dummy Shaft Tool, 14 TPI Qty. 1**FKITMKVHP - MW32A, MWS36A, MWS40A Valve removal / Installation Tool Kit D**

Includes:	F27516000	Outlet valve housing O-ring	Qty. 1
	F27516400	Outlet and suction valve units	Qty. 1
	27516200	Suction valve housing	Qty. 1
	800049	10 mm Thread Bushing	Qty. 1
	520426	Valve Cage Adapter	Qty. 1

5. SPECIAL VERSIONS

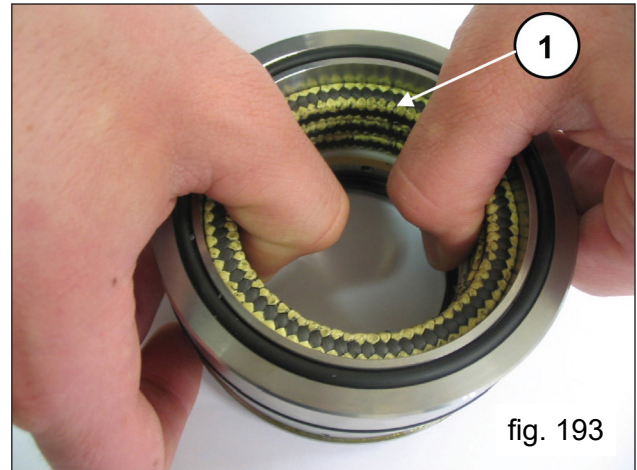
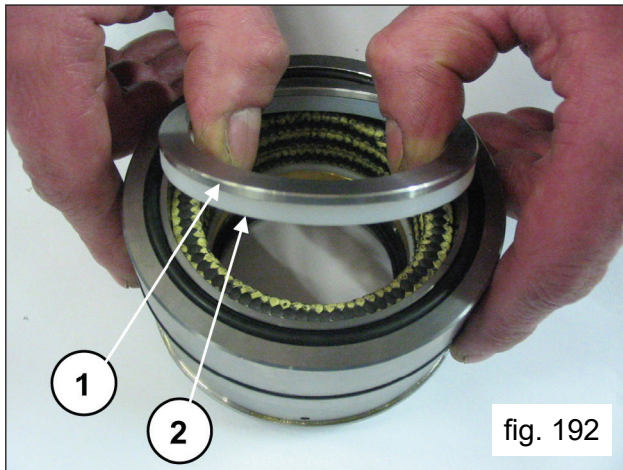
The instructions for repairing special versions are given below. Unless specified otherwise, refer to the information above for the standard MW pump.

- MWN – MWF pumps: for repair, follow the instructions for the standard MW pump.
- MWR – MWNR pumps: for repair, follow the instructions for the standard MW pump with the exception of the pressure seals, for which it is necessary to follow the dedicated paragraph.

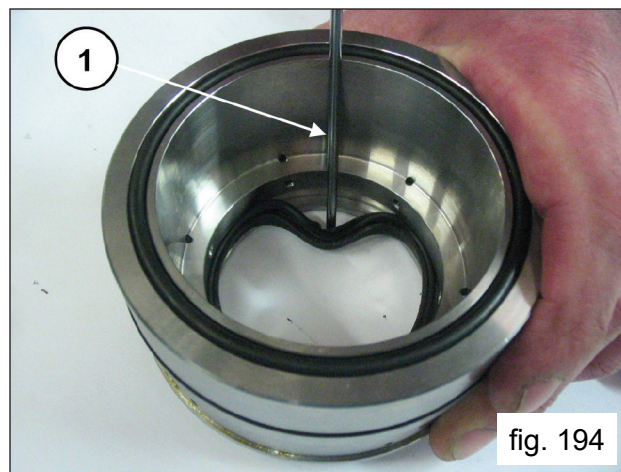
5.1 MWR - MWNR PUMP

5.1.1 Disassembly of the support seal unit

Separate the seal support from the liner, remove the spring ring and scraper ring (1,2, fig. 192) to access the pressure seals (1, fig. 193).



To remove the low pressure seal, use a thickness gauge or another tool which will not damage the seal support housing (1, fig. 194).



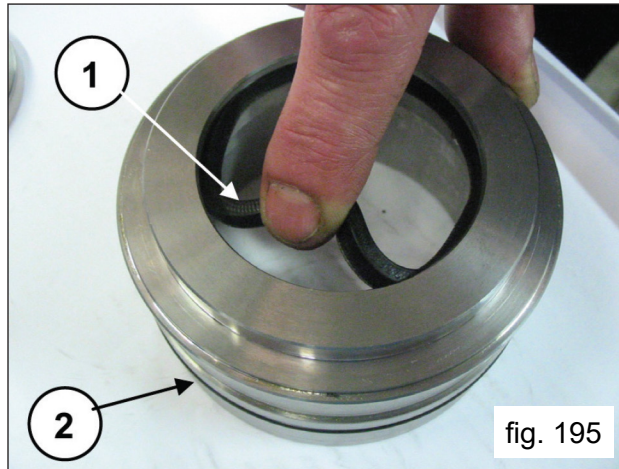


Replace the pressure seals moistening the lips with silicone grease (without spreading it), taking extra care not to damage them during liner insertion.

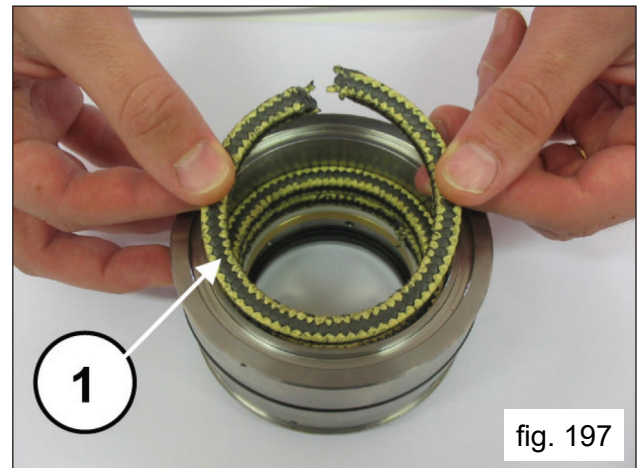
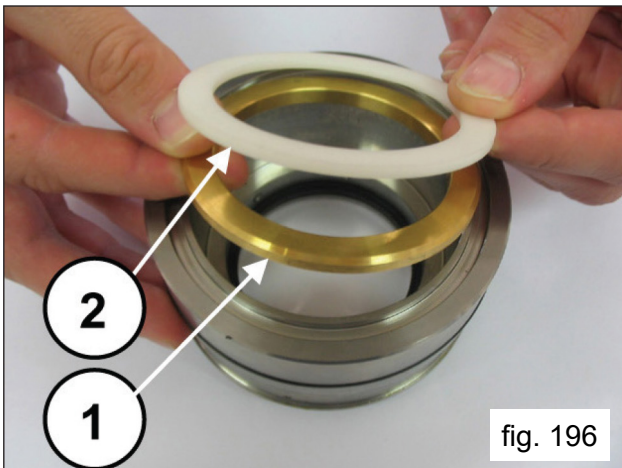


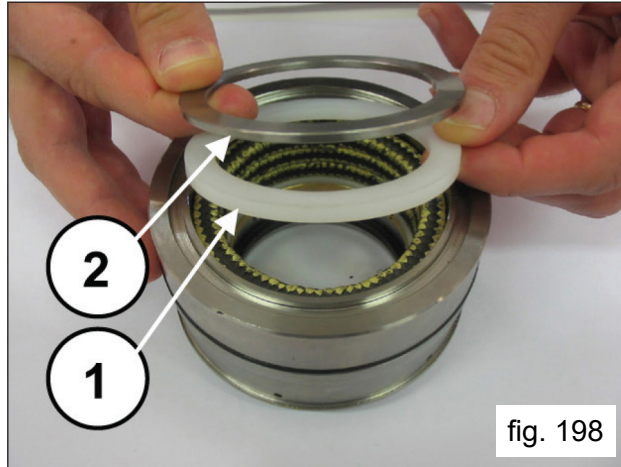
The O-rings and the low pressure seals must be replaced at each disassembly.

Insert the low pressure seal in the KC seals support (1, fig. 195) paying attention to the mounting direction which requires that the sealing lip be set forward (towards the head) and the O-ring (2, fig. 195).

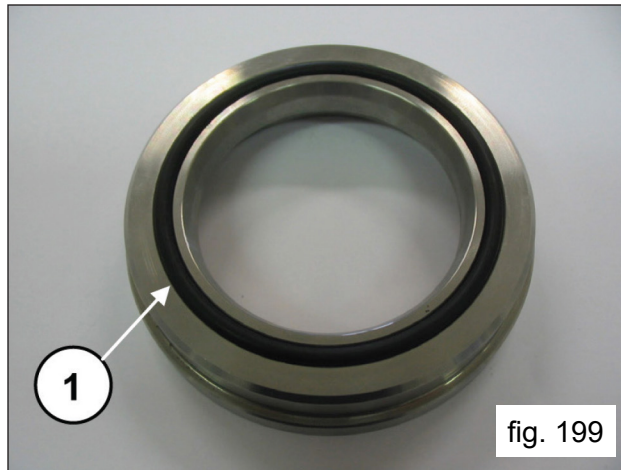


Assemble the support ring and the anti-extrusion ring (1,2, fig 196), the three KC sealing rings, making sure the notches are at 120° from each other (1, fig. 197), the KC seals scraper ring and the spring ring (1,2, fig. 198).





Now assemble the O-ring (1, fig. 199) on the KC seals head ring and position it in the seat on the head.



6. MAINTENANCE LOG

HOURS & DATE

OIL CHANGE							
GREASE							
PACKING REPLACEMENT							
PLUNGER REPLACEMENT							
VALVE REPLACEMENT							



GP Companies, Inc.
1174 Northland Drive
Mendota Heights, MN 55120
Phone:651.686.2199 Fax: 800.535.1745
www.generalpump.com email: sales@gpcompanies.com

Ref 300791 Rev. H
10-23