



# HTCK3623S

## Repair Manual



General Pump  
is a member of  
the Interpump Group



Ref 300935 Rev. B  
07-23

## INDEX

<b>1.</b>	<b>INTRODUCTION</b> .....	Page 3
<b>2.</b>	<b>REPAIR GUIDELINES</b> .....	Page 3
	2.1 Repairing Mechanical Parts .....	Page 3
	2.1.1 Disassembly of Mechanical Parts .....	Page 4
	-Remove the piston guide seal rings as described below: .....	Page 5
	2.1.2 Reassembly of Mechanical Parts .....	Page 6
	2.1.3 Reduction Classes .....	Page 8
	2.1.4 Disassembly/Reassembly of Bearings and Shims .....	Page 8
	2.2 Repairing Hydraulic Parts .....	Page 11
	2.2.1 Dismantling the Head-Valve Units .....	Page 11
	2.2.2 Reassembling the Head-Valve Units .....	Page 12
	2.2.3 Dismantling the Head-Seals .....	Page 13
	2.2.4 Dismantling the Piston Unit .....	Page 15
	2.2.5 Reassembling the Head-Seals-Piston Unit .....	Page 15
<b>3.</b>	<b>SCREW CALIBRATION</b> .....	Page 16
<b>4.</b>	<b>REPLACING THE CONNECTING ROD FOOT BUSHING</b> .....	Page 17
<b>5.</b>	<b>REPAIR TOOLS</b> .....	Page 18
<b>6.</b>	<b>MAINTENANCE LOG</b> .....	Page 19

## 1. INTRODUCTION

This manual describes the instructions for repair of the HTCK3623S, and must be carefully read and understood before performing any repair intervention on the pump. Proper pump operation and longevity depend on the correct use and maintenance. General Pump declines any responsibility for damage caused by negligence or failure to observe the instructions described in this manual.

## 2. REPAIR INSTRUCTIONS

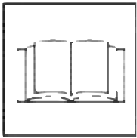

### 2.1 Repairing Mechanical Parts

Mechanical parts repair must be performed after the oil has been removed from the casing. To drain the oil, remove the oil dipstick, (1, fig. 1) and then the draining plug (2, fig. 1).

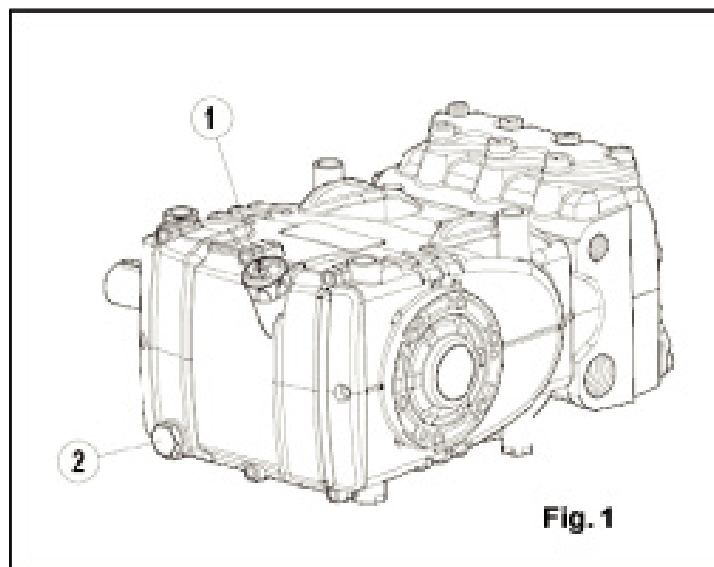

The oil must be placed in a suitable container and disposed of in special centers. It absolutely must not be discarded into the environment.

## 2.1.1 DISASSEMBLY OF MECHANICAL PARTS

The operations described must be performed after removing the hydraulic part, ceramic plungers and splash guards from the pump (see 2.2.3 and 2.2.4).

Remove in the following order:

- the pump shaft tab
- the rear cover
- the connecting rod cap as follows:

unscrew the cap fixing screws, remove the connecting rod caps with their lower half-bearings (fig. 2) paying attention to the numbered sequence during disassembly.

*To avoid possible errors, caps and connecting rod shanks have been numbered on one side (fig. 2a, 1).*

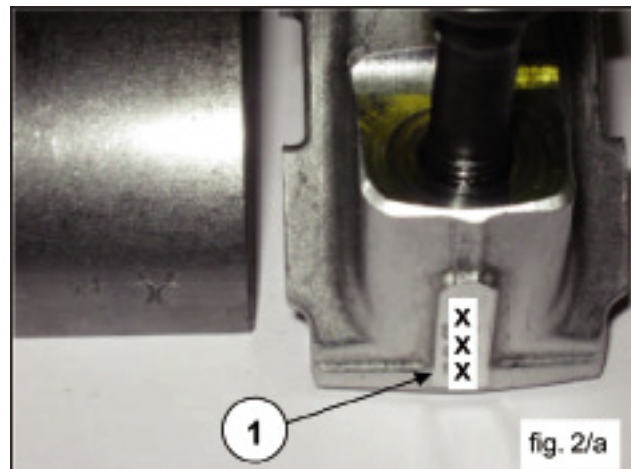
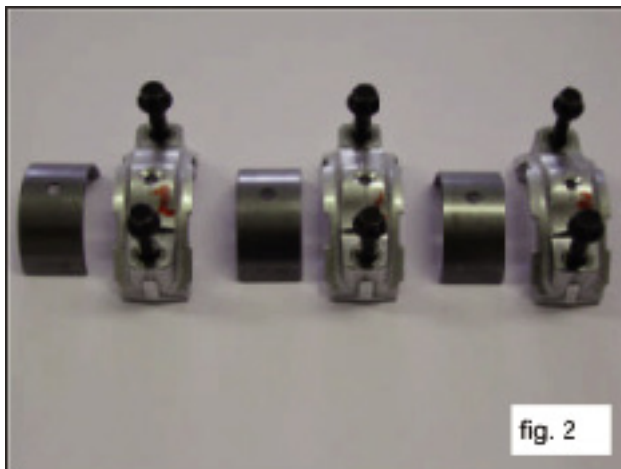

- the side covers using - for extraction - 3 fully threaded M6x50 screws, inserting them in the threaded holes as indicated in fig. 3.

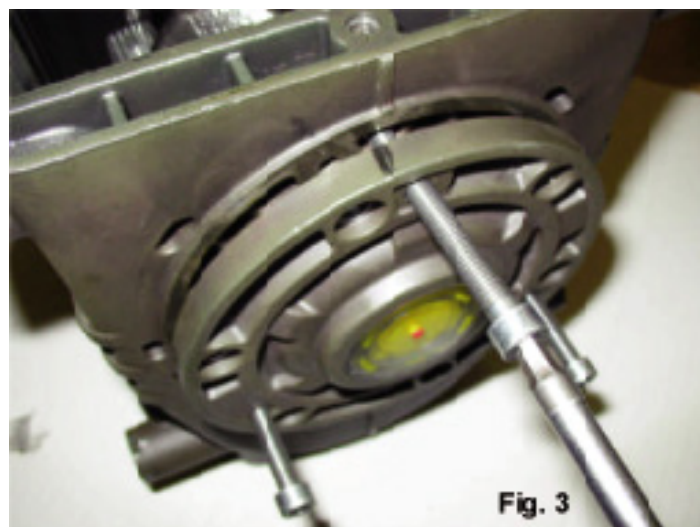

-push the plunger guides forward with their con-rods to facilitate side extraction of the pump shaft as shown in fig. 4



- Remove the pump shaft
- Complete disassembly of the con-rod units by removing them from the pump casing and removing the plunger guide pins
- Remove the pump shaft seal rings using common tools
- Remove the plunger guide seal rings as described below:

Use the extractor, p/n 26019400 (fig. 5, 1) and the gripper p/n 27503800 (fig. 5, 2). Insert the gripper as far as possible onto the seal ring with the aid of a hammer (fig. 5a), subsequently screwing the extractor to the gripper, and use the extractor hammer (fig. 5b) until the ring to be replaced is removed (fig. 5c).

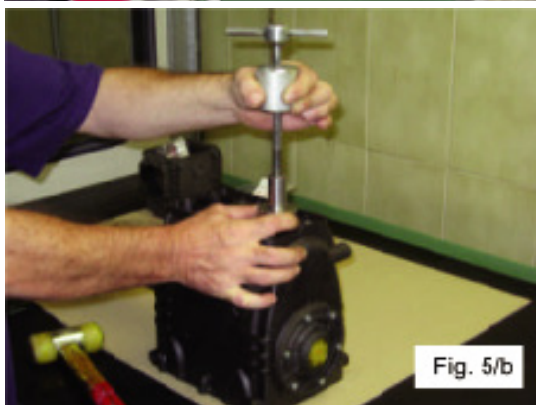
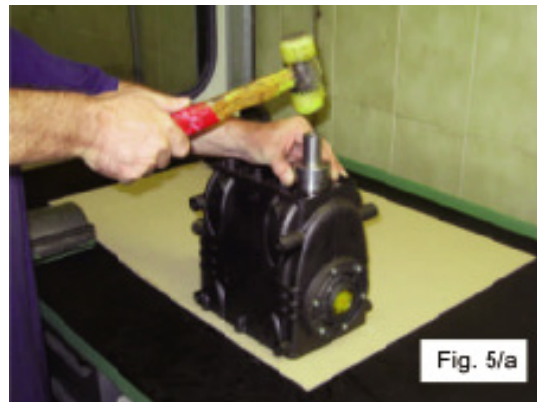
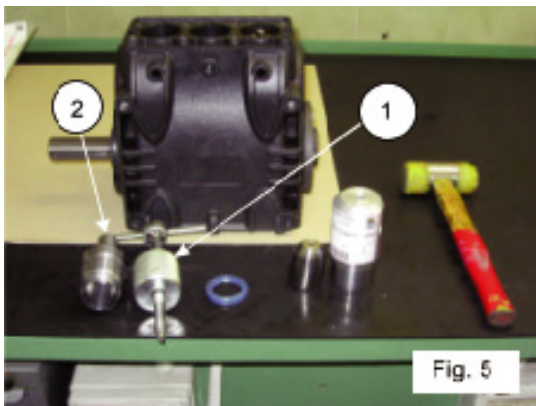

## 2.1.2 REASSEMBLY OF MECHANICAL PARTS

After having checked that the casing is clean, proceed with assembly of the mechanical part as described below:



- Assemble the upper and lower half-bearings in their seats in the con-rods and caps.  
**Make sure that the reference marks on the upper half-bearings (fig.6, 1) and lower half-bearings (fig. 6a, 2) are positioned in their respective seats in the con-rod and cap.**

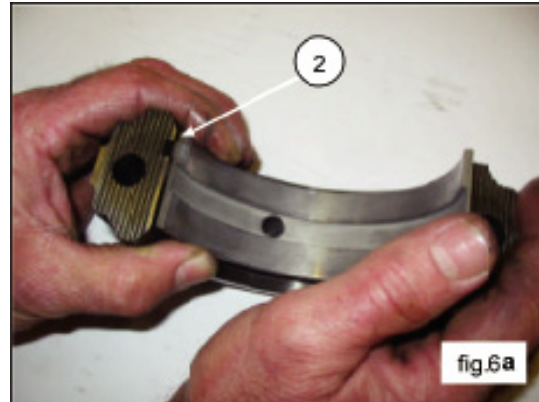
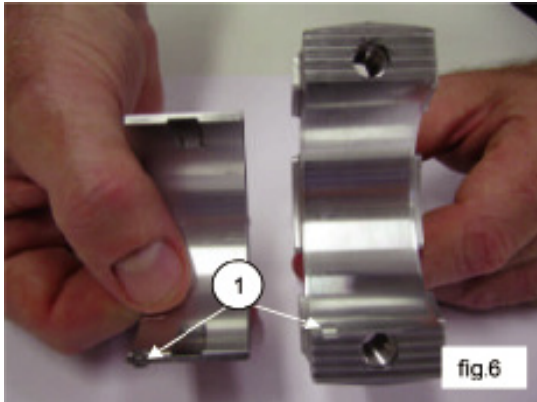

-Insert the piston/con-rod guide units into the pump casing, directing the numbering on the con-rod shank towards the top of the casing, taking care not to damage the piston guide seal rings.

To facilitate pump shaft insertion (without the tab), it is essential to repeat the operation performed during disassembly, pushing the piston/con-rod guide units as far down as possible (paragraph 2.2.1).

-Before assembling the side cover on the PTO side, check the conditions of the radial ring lip seal and relative contact area on the shaft.

If replacement is necessary, position the new ring using a tool p/n 27904500) as indicated in fig. 7.



- If the pump shaft shows diametrical wear in the area of contact with the lip seal, in order to prevent the grinding operation, it is possible to reposition the ring in abutment with the cover as shown in fig. 7.**

Before assembling the side covers, make sure there are O-rings on both of them and shim rings on the indicator side cover only. To facilitate filling of the first section and relative insertion of the covers on the casing, we recommend using three partially threaded M6x40 screws (fig. 8,1), then completing the operation with the screws supplied (M6x18).

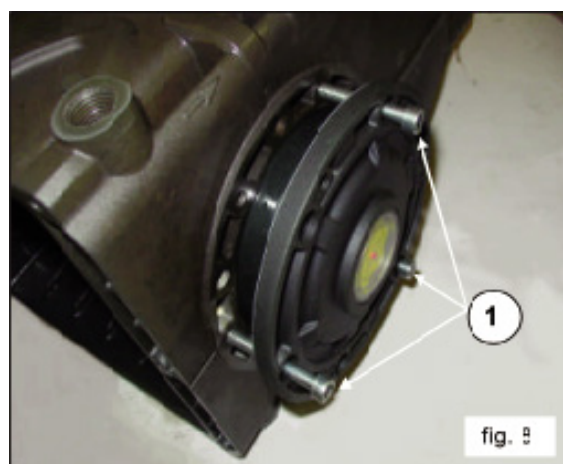
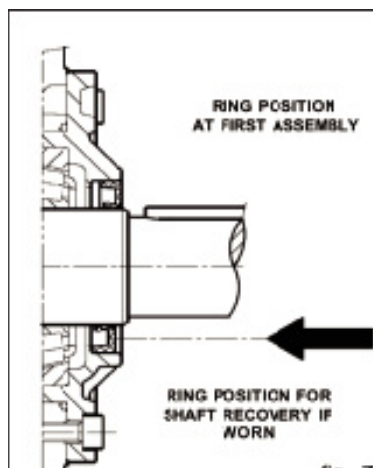



-Couple the con-rod caps to their shanks, referring to the numbering (fig. 9, 1).  
**Note the correct assembly direction of the caps.**

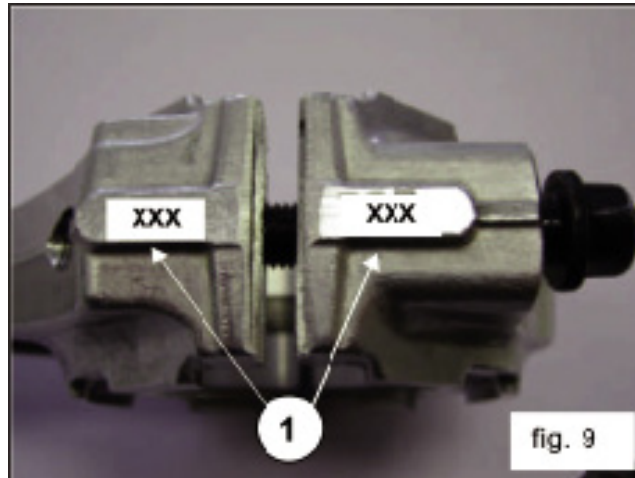

Fasten the caps to their respective con-rod shanks by means of M8x1x42 screws (fig. 10) lubricating both the underhead and the threaded shank. Proceeding in two different stages.



1. Manually turn the screws until they begin to tighten
  2. Tighten torque: 22 ft.lbs. (30 Nm)
- Alternately, ensure:
1. Pre-tightening torque: 7-11 ft.lbs. (10-15 Nm)
  2. Tightening torque: 22 ft.lbs. (30 Nm)



-After having completing tightening operations, check that the con-rod head has a side clearance in both directions.

-Insert the new plunger guide seal rings as far as possible into the relative seat on the pump casing (fig. 11), following the procedure described:

Using tool p/n 27904200 composed of a tapered bushing and a buffer. Screw the tapered bushing into the hole in the plunger guide (fig. 11a). Insert the new seal ring on the buffer as far as it will go (determined by the height of the buffer) into its seat on the pump casing (fig. 11b), remove the tapered bushing (fig. 11c).

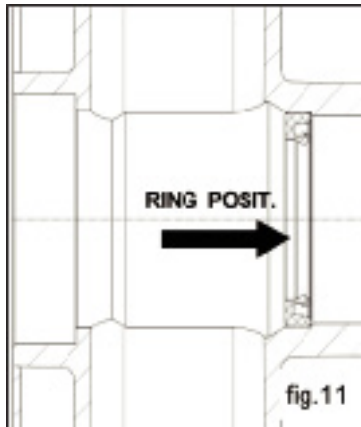

- Mount the rear cover complete with the O-ring, positioning the dipstick hole upward.
- Insert oil in the casing as indicated on the specification sheet.

### 2.1.3 REDUCTION CLASSES

TABLE OF REDUCTIONS FOR CRANKSHAFTS AND CON-ROD HALF-BEARINGS			
Recovery Classes (mm)	P/N Half-bearing Upper	P/N Half-bearing Lower	Correction on the shaft pin diameter (mm)
0.25	90922100	90922400	Ø39.75 0/-0.02 Ra 0.4 Rt 3.5
0.50	90922200	90922600	Ø39.50 0/-0.02 Ra 0.4 Rt 3.5

### 2.1.4 DISASSEMBLY/REASSEMBLY OF BEARINGS AND SHIMS

The type of bearings (taper roller) ensures the absence of axial clearance on the crankshaft. The shims are defined to meet this necessity. For disassembly/reassembly and for any replacements, carefully observe the following directions:



**A) Disassembly/Reassembly of the crankshaft without bearings replacement.**

After having removed the side covers as indicated in point 2.1.1, check the conditions of the rollers and their relative tracks. If all parts are in good condition, clean the components carefully with a degreaser and redistribute lubricant oil uniformly.

The previous shims can be reused, taking care to insert them only under the indicator side cover.

Once the complete unit (indicator side flange + shaft + motor side flange) is assembled and the cover screws have been tightened to the recommended torque, check that the rotation torque of the con-rod shaft - with the con-rod disconnected - is a minimum of 3 ft.lbs. (4 Nm) and a max. of 4.4 ft. lbs.(4-6 Nm).

To bring the two side covers closer to the casing, it is possible to use 3 M6x40 screws for the first positioning phase as indicated in fig. 6 and the screws provided for final fastening.

Shaft rotation torque (with the con-rod connected) should not exceed 6 ft.lbs. (8 Nm),

**B) Disassembly/Reassembly of the crankshaft with bearings replacement.**

After having removed the side covers as indicated in point 2.2.2, remove the outer ring nut of the bearings from the relative covers and the inner ring nut with the remaining part of the bearing from the two ends of the shaft by means of a normal "pin punch" or a similar tool as indicated in figs. 8 and 9.

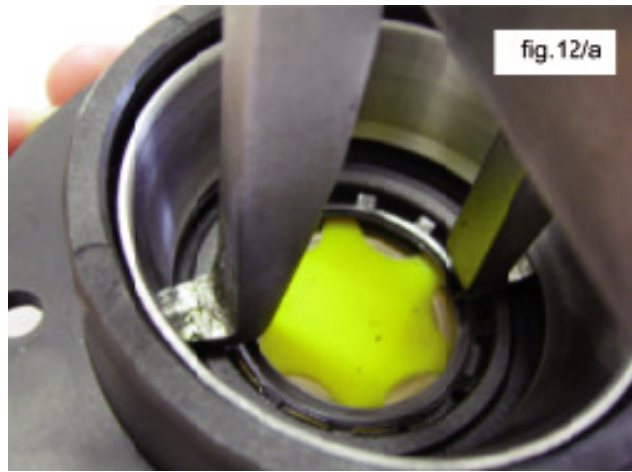

The new bearings can be mounted cold with a press or rocker, supporting it on the lateral surface of the ring nuts involved in press fitting with the rings. The press fitting operation can be facilitated by heating the involved parts to a temperature between 250°-300° F (120°-150° C), ensuring that the ring nuts fit fully into their seats.



**Never exchange the parts in the two bearings.**

**C) Determining the shim pack:**

Perform the operation while the piston/con-rod units are assembled, the con-rod caps are disconnected and the con-rods are pushed downwards. Insert the pump shaft without tab into the casing, making sure the PTO shank comes out of the correct side.

Secure the PTO side flange to the casing, taking care with the lip seal as described previously and tighten the fixing screws to the recommended torque.

Then feed the flange on the indicator side without shims in the cover and start to move it closer, manually screwing the M4x40 service screws in equally, with small rotations such as to move the cover in slowly and correctly.

At the same time, check that the shaft rotates freely by turning it manually.

Continuing the procedure in this way, a sudden increase in difficulty during shaft rotation will soon be experienced.

At this point, halt the forward movement of the cover and loosen the fixing screws completely.

With the aid of a thickness gauge, measure the clearance between the side cover and pump casing (fig. 14).



Proceed to determine the shim pack, using the table below:

Detected Measurement	Shim Type	Number of Pieces
From: 0.05 to 0.10	/	/
From: 0.11 to 0.20	0.1	1
From: 0.21 to 0.30	0.1	2
From: 0.31 to 0.35	0.25	1
From: 0.36 to 0.45	0.35	1
From: 0.46 to 0.55	0.35	1
From: 0.56 to 0.60	0.10	1
From: 0.56 to 0.60	.25	2
From: 0.61 to 0.70	0.35	1
From: 0.61 to 0.70	0.24	1



Once the type and number of shims have been determined using the table, check the following: assemble the shim pack on the indicator side cover centering (fig. 15). Secure the cover to the casing, following the procedure in part 2.1.2 and tighten the screws to their recommended torque.

Check that the shaft rotation stall torque is between 3-4.3 ft.lbs.(4-6 Nm).

If this torque is correct, connect the con-rods to the crankshaft and to the next stages. If it is not, redefine the shim pack, repeating the operations.

## 2.2 REPAIRING HYDRAULIC PARTS

### 2.2.1 DISMANTLING THE HEAD - VALVE UNITS

Operations are limited to inspection or replacement of valves, if necessary.  
Proceed as follows to extract valve groups:

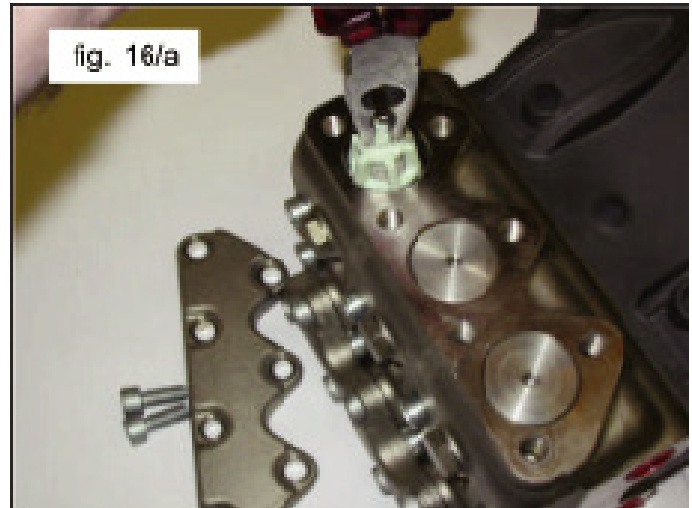

- Unscrew the 7 M12x35 valve cover fixing screws and remove covers (fig. 16, 16a).
- Extract valve plugs by means of an extractor hammer or an M6 threaded car (fig. 16)
- Extract valve units using a gripper (fig. 16a).



**If the suction and outlet valves remain stuck on the head (for example because of incrustations due to prolonged lack of use of the pump), proceed as follows:**

- using extractor tool p/n 26019400 combined with tool p/n 27513700 (fig. 16b).

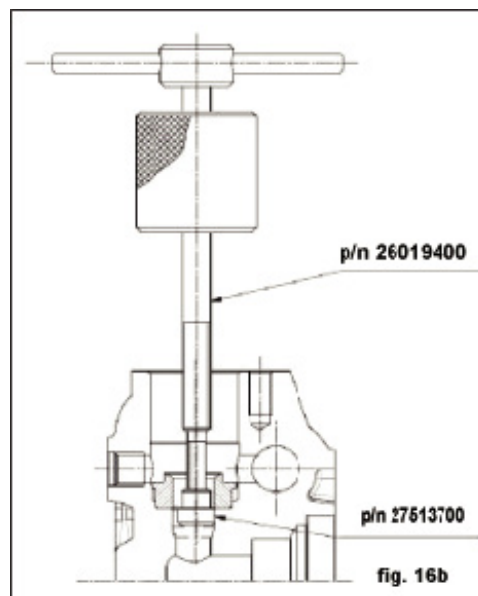

- To dismantle the suction-outlet valves, simply use a tool as indicated in fig. 14

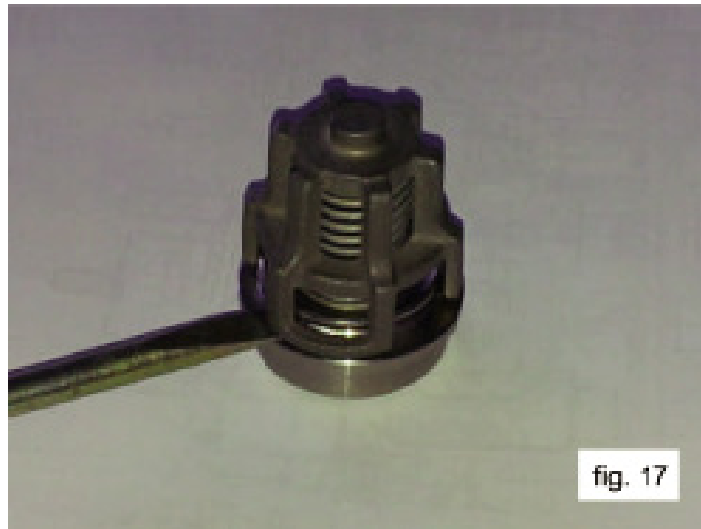

## 2.2.2 REASSEMBLING THE HEAD - VALVE UNITS



Pay particular attention to the conditions of the various components and replace if necessary, and at intervals indicated in the 'PREVENTIVE MAINTENANCE' on the specification sheet.

**At every valve inspection, replace all O-rings and all anti-extrusion rings both in the valve groups and on the valve plugs.**



Before repositioning the valve unit, thoroughly clean and dry the relative seats in the head as shown in fig. 18.

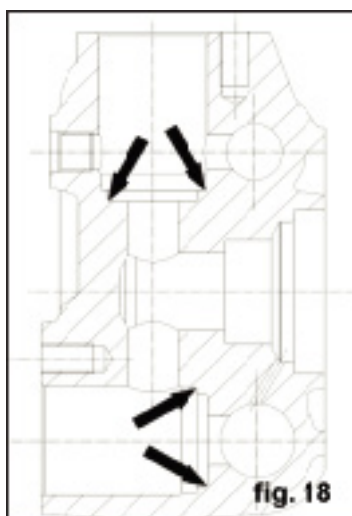

To reassemble the various components, follow the reverse operations listed above as described in point 2.2.1. To facilitate insertion of the valve guide in its housing, you can use a brush resting on the horizontal guide planes and use a hammer acting on the whole circumference (figs. 19a).

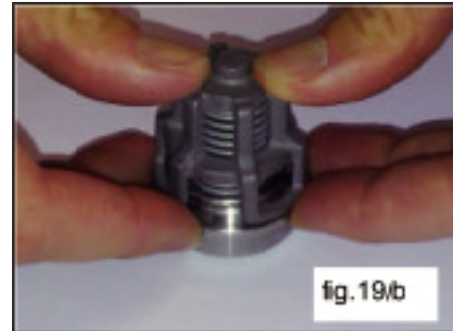
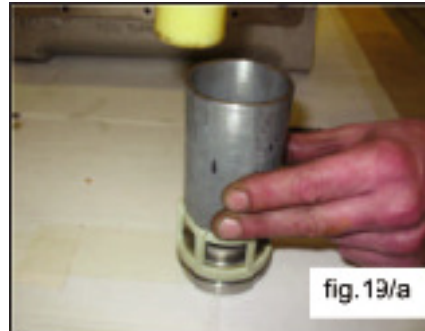
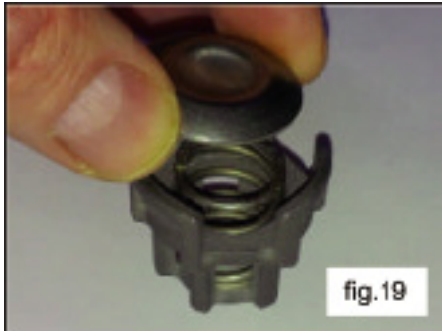

**Insert the suction and outlet valve units, checking that they are down to end stroke in the head housing. Then apply the valve covers and calibrate the respective M12x25 screws using a torque wrench at the required tightening torque.**

### 2.2.3 DISMANTLING THE HEAD - SEALS

Replacement of the seals is necessary from the moment you begin to detect water leaks from the drainage holes provided on the back of the pump casing, and at the intervals indicated in the "Preventive Maintenance" section on the specification sheet.

A) Unscrew the M10x110 head fixing screws as indicated in fig. 20.

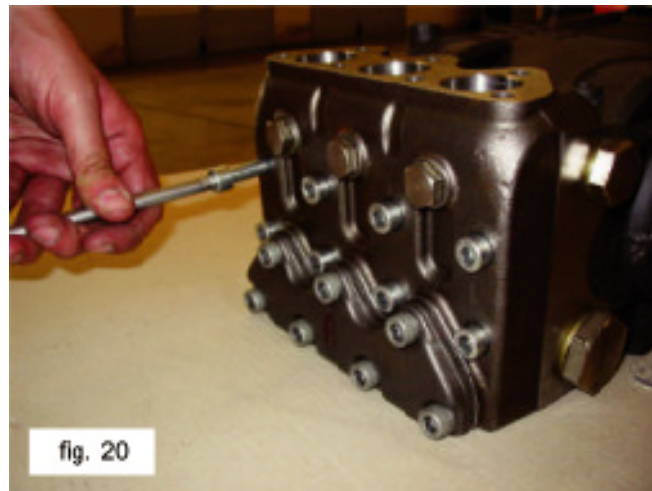

B) Separate the head from the pump casing

C) Extract the high pressure seals from the head and the low pressure ones from the support, using simple tools as indicated in (fig. 21) being careful not to damage the respective housing.

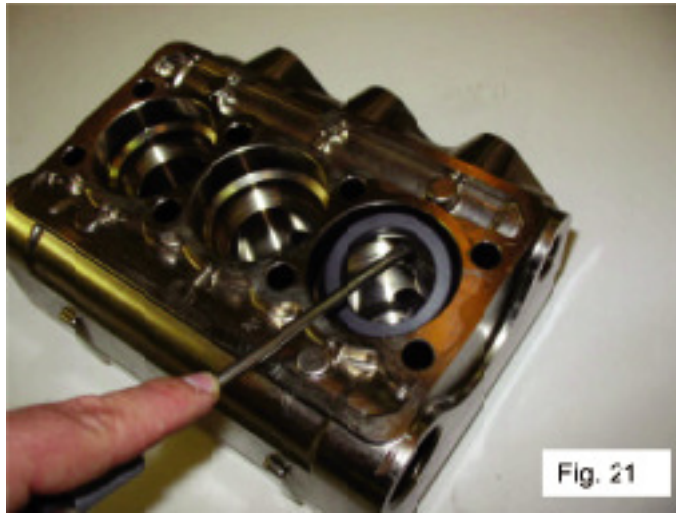

Pay attention to the order of seal pack disassembly as indicated in fig. 23 composed of:

1. High pressure seal ring
2. Intermediate ring
3. Low pressure seal ring
4. Bottom ring
5. O-ring

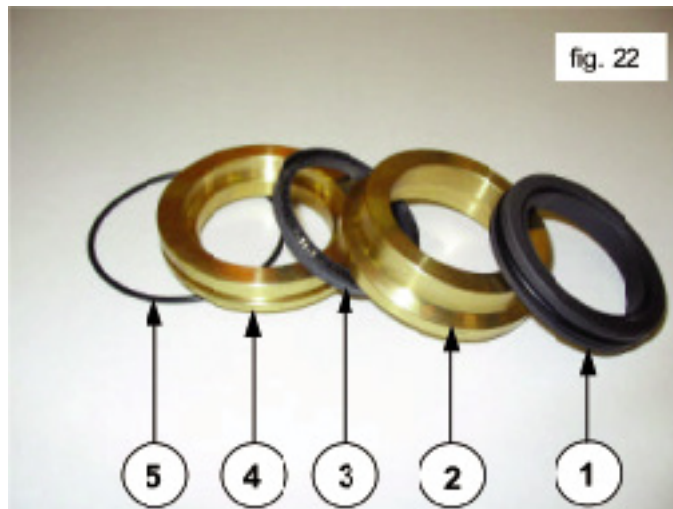

## 2.2.4 DISMANTLING THE PISTON UNIT

The piston unit does not require any routine maintenance. Maintenance is limited to visual checks only. Proceed as follows to remove the piston units:

A) Unscrew the piston fixing screws as indicated in fig. 23.

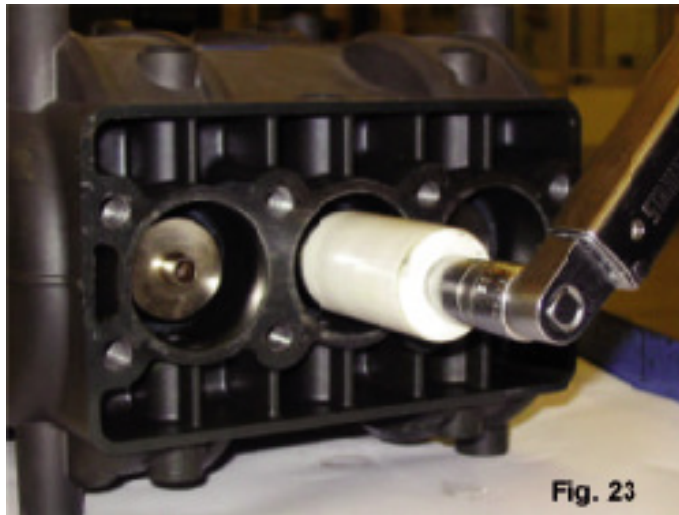

B) Check and verify their conditions, replace if necessary.



**At every disassembly, all O-rings on the piston unit must be replaced.**

## 2.2.5 REASSEMBLING THE HEAD - SEALS - PISTON UNIT

To reassemble the various components, follow the reverse operations listed above as described in point 2.2.3, taking particular care to the described instructions:

- A) Seals pack: respect the same order used during disassembly operations.
- B) Lubricate components 1 and 3 with OCILIS 250 silicone grease p/n 12001600; only on the external diameter.
- C) For correct assembly of HP seals in their housing on the head without causing any damage to lip seals, use suitable tools according to the pump diameters as indicated in Chapter 5.
- D) Replace the piston, tightening the screws with a torque wrench, respecting the tightening torque as indicated in Chapter 3.
- E) Assembling the head: for the values of the torques and tightening sequences follow the instructions in Chapter 3.

## 3. SCREW TIGHTENING CALIBRATION

Description	Exploded Drawing Position #	Tightening Torque
Cover fixing screw	9	7.4 ft.lbs. (10 Nm)
Piston fixing screw	28	14.8 ft.lbs (20 Nm)
Connecting rod cap fixing screw	16	22.1 ft.lbs (30 Nm)*
Head fixing screw	39	29.5 ft.lbs (40 Nm)**
Valve cover fixing screws	40	59.0 ft.lbs (80 Nm)***
Oil discharge plug	11	29.5 ft.lbs (40 Nm)
G1" outlet plug	31	73.8 ft.lbs (100 Nm)
G1-1/2" suction plug	29	88.5 ft.lbs (120 Nm)
Type "A" flange fixing screw	66	16.2 ft.lbs (22 Nm)

\* The connecting rod cap fixing screws must be tightened respecting the stages indicated on page 7

\*\* The head fixing screws must be tightened with a torque wrench, lubricating the underhead, respecting the order in fig. 24

\*\*\* The valve cover fixing screws must be tightened with a torque wrench, lubricating the underhead, respecting the order in fig. 24

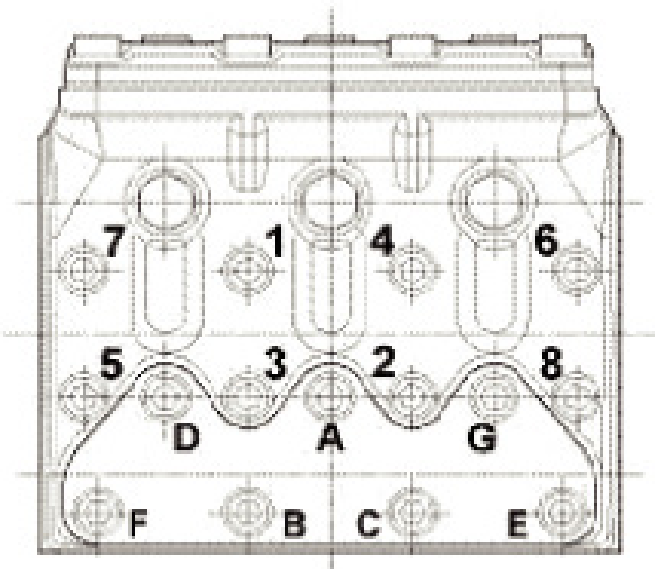



Fig. 24



## 4. REPLACING THE CONNECTING ROD FOOT BUSHING

During maintenance, if it becomes necessary to replace the connecting rod foot bushing, proceed as follows:

 **When removing the worn bushing, take great care not to damage or scratch the seat on the connecting rod.**

Perform cold press fitting of the new bushing. During this operation, ensure that:

- the lubrication hole coincides with the corresponding hole on the connecting rod;
- the cutting junction is directed as shown in fig. 25

 **Then perform mechanical processing. The dimensions and tolerances shown in fig. 25 MUST be respected.**

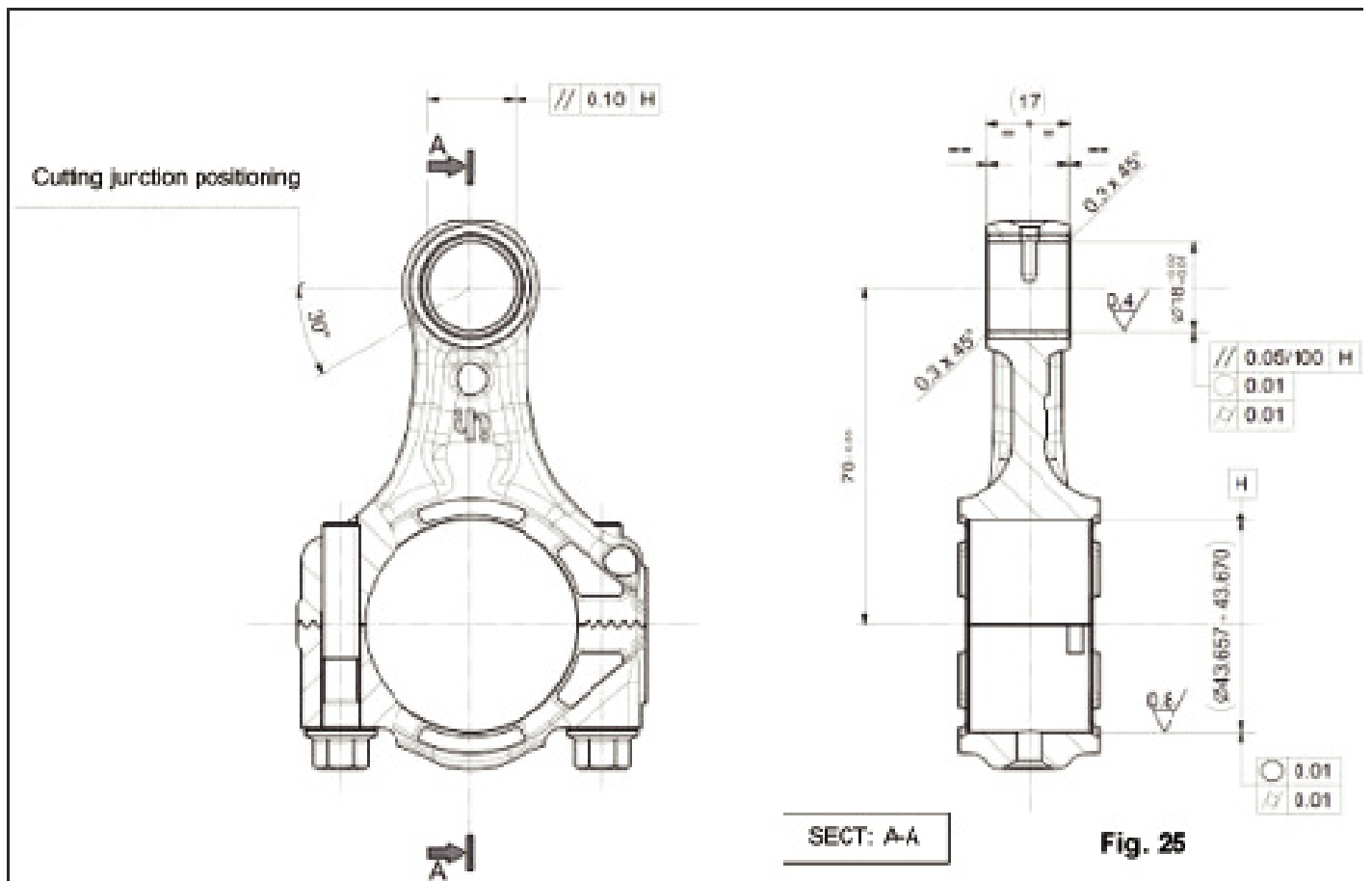

## 4. REPAIR TOOLS

Pump maintenance and repairs are facilitated by the use of special tools, listed in the table below:

### For Assembly:

- Seal bushing Ø 48; HP alternative seal ring Ø 36x48x8 ..... 26406300  
27465800
- Buffer for pump shaft oil seal ..... 27904500
- Buffer for piston guide oil seal ..... 27904200

### For Disassembly:

- Suction/outlet valve seat. .... 26019400  
27513700
- Piston guide oil seal extraction gripper ..... 26019400  
27503800

## 5. MAINTENANCE LOG

### HOURS & DATE

<b>OIL CHANGE</b>							
<b>GREASE</b>							
<b>PACKING REPLACEMENT</b>							
<b>PLUNGER REPLACEMENT</b>							
<b>VALVE REPLACEMENT</b>							



GP Companies, Inc.  
1174 Northland Drive  
Mendota Heights, MN 55120  
Phone: 651.686.2199 Fax: 800.535.1745  
www.generalpump.com email: sales@gpcompanies.com

Ref 300935 Rev. B  
07-23