

# Fixed Injector

Quick Connect



## SPECIFICATIONS

Part Number	100594	100570	100595	100571	100616	100572
Nozzle Diameter	.070"		.083"		.091"	
Max Volume	2-3 GPM		3-5 GPM		5-8 GPM	
Max Pressure	3,500 PSI					
Flow Direction	F → M	M → F	F → M	M → F	F → M	M → F
MaxTemp	190° F					
Inlet Port - 3/8" QD	Coupler	Plug	Coupler	Plug	Coupler	Plug
Outlet Port - 3/8" QD	Plug	Coupler	Plug	Coupler	Plug	Coupler
Hose Barb Size	5/16"					
Dimensions	2.625" L x 1.125" W x 2.5" H					
Weight	0.38 lbs.					
Materials	Brass, Stainless Steel, Viton					

## PARTS LIST

Item	Part No.	Description	QTY.
1	510258	Housing, Injector, 3/8" QD, MF, Brass (100570)	1
	510247	Housing, Injector, 3/8" QD, MF, Brass (100571, 100572)	
	510265	Housing, Injector, 3/8" QD, FM, Brass (100594)	
	510266	Housing, Injector, 3/8" QD, FM, Brass (100595, 100616)	
2	720040*	Spring, Conical, .437" FL, 316 SS	1
3	520008*	Ball, Injector, 316 SS	1
4	701008*	O-Ring, 70 Duro, Viton, .176" ID x .070" CS	1
5	510248	Hose Barb, QD Injector, Brass	1
6	520116**	Nozzle, QD Injector, Ø .070", 303 SS (100570, 100597)	1
	520115**	Nozzle, QD Injector, Ø .083", 303 SS (100571, 100595)	
	520127**	Nozzle, QD Injector, Ø .091", 303 SS (100572, 100616)	
7	5200117	Ball, 5/32", 440C	8
8	701049*	O-Ring, 70 Duro, Viton, .478" ID x .103 CS	1
9	720041	Spring, .920" OD, .62" FL, 302 SS	1
10	510249	Collar, 3/8" QD, Brass	1
11	202031	Retaining Ring, .74" ID, .048" CS, 302 SST	1
*	100592	Repair Kit	
**		Additional Available Parts	

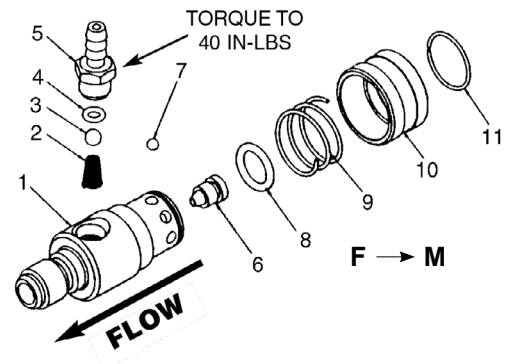
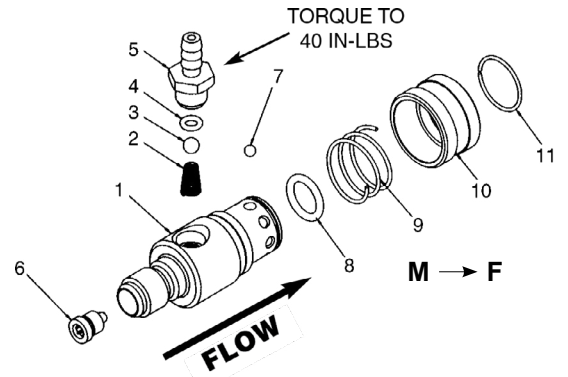

General Pump  
is a member of  
the Interpump Group



300085 Rev. D  
08-18



# Adjustable Injector

Quick Connect



## SPECIFICATIONS

Part Number	100617	100575	100618	100576	100619	100577
Nozzle Diameter	.070"		.083"		.091"	
Max Volume	2-3 GPM		3-5 GPM		5-8 GPM	
Max Pressure	3,500 PSI					
Flow Direction	F → M	M → F	F → M	M → F	F → M	M → F
MaxTemp	190° F					
Inlet Port - 3/8" QD	Coupler	Plug	Coupler	Plug	Coupler	Plug
Outlet Port - 3/8" QD	Plug	Coupler	Plug	Coupler	Plug	Coupler
Hose Barb Size	5/16"					
Dimensions	2.625" L x 1.125" W x 2.5" H					
Weight	0.38 lbs.					
Materials	Brass, Stainless Steel, Viton					

## PARTS LIST

Item	Part No.	Description	QTY.
1	510258	Housing, Injector, 3/8" QD, MF, Brass (100575)	1
	510247	Housing, Injector, 3/8" QD, MF, Brass (100576, 100577)	
	510265	Housing, Injector, 3/8" QD, FM, Brass (100617)	
	510266	Housing, Injector, 3/8" QD, FM, Brass (100618, 100619)	
2	720040*	Spring, Conical, .437" FL, 316 SS	1
3	520008*	Ball, Injector, 316 SS	1
4	701008*	O-Ring, 70 Duro, Viton, .176" ID	1
5	510262	Post, Adjustable Hose Barb, Brass	1
6	520116**	Nozzle, QD Injector, Ø .070" 303 SS (100575, 100617)	1
	520115**	Nozzle, QD Injector, Ø .083" 303 SS (100576, 100618)	
	520127**	Nozzle, QD Injector, Ø .091" 303 SS (100577, 100619)	
7	520117	Ball 5/32", 440C	8
8	701049*	O-Ring, 70 Dura, Viton, .478 ID x .103 CS	1
9	720041	Spring, .920" OD, .62" FL, 302 SS	1
10	510249	Collar, 3/8" QD, Brass	1
11	202031	Retaining Ring, .74" ID, .048" CS, 302 SS	1
12	701501*	O-Ring, 70 Duro, Viton, .208" ID x .070" CS	1
13	510263	Knob, Adjustment Hose Barb, Brass	1
14	201002	Set Screw	1
*	100592	Repair Kit	
**		Additional Available Parts	

